

ADR2000

Version A

Version B

**ANALOG/DIGITALRS232/RS485
INTERFACE**

USER MANUAL

V 3.0

Caution: The **ADR2000** is a static sensitive device. Observe proper procedures for handling static sensitive devices.

ONTRAK CONTROL SYSTEMS INC.

764 Notre Dame Avenue

Unit # 1

Sudbury Ontario

CANADA P3A 2T2

(705) 671-2652 (VOICE)

(705) 671-6127 (FAX)

www.ontrak.net (**WEB**)

Ontrak Control Systems Inc. reserves the right to change product specifications to improve the product.

Although every attempt has been made to insure accuracy of information contained in this manual, **Ontrak Control Systems Inc.** assumes no liability for inadvertent errors.

Warranty: This ADR2000 is warranted from defects in workmanship and materials for a period of 90 days. Liability for defects is limited to the purchase price of the product. This warranty shall not apply to defects resulting from improper modifications or use outside published specifications.

Hyperterminal and Windows are trademarks of Microsoft Corporation.
APPLE , MACINTOSH and MAC are trademarks of Apple Computer Inc.
PC, XT, AT, PS/2 are trademarks of International Business Machines Inc.
COPYRIGHT 1999 ONTRAK CONTROL SYSTEMS INC.

TABLE OF CONTENTS

READ ME FIRST	3
1. Communication options.	
a) The ADR2000 RS232 Interface.	4
b) The ADR2000 RS485 Interface	5
2. Powering the ADR2000	5
3. ADR2000 Commands	6
a) Analog Input Commands	7
b) Analog Output Commands	8
c) Digital Port Commands	9
d) Event Counter Commands	10
e) ID Command	11
4. Using BASIC with ADR Products	12
5. Using TURBO C with ADR Products	13
6. Daisy Chain Options for the ADR2000	16
7. Interfacing to the ADR2000 (basic examples)	
a) Reading Potentiometer Position	17
b) Connecting Switches to Digital Ports	18
c) Connecting LED'S to Digital Ports	19
d) Driving Solid-State Relays	19
e) Solid-state Temperature Measurement	20
f) Event-Counter Connections	21

APPENDIX

A-CONNECTION DIAGRAM	22
B-ELECTRICAL SPECIFICATIONS	23
C-MOUNTING DIMENSIONS	24

READ ME FIRST

Thank you for purchasing this ADR2000 serial data acquisition interface. There are three steps to using the ADR2000.

- 1.Connecting your computer or terminal to the ADR2000.
- 2.Providing power to the ADR2000.
- 3.Sending commands to the ADR2000.

This manual will provide guidance for completing these steps along with BASIC and TURBO C programming tips. An applications section is also provided to describe how to interface various electronic transducers and other devices to the ADR2000. Additional applications and programming examples are available on our web page at <http://www.ontrak.net/>

FEATURES

- 8, 12-bit analog inputs (0 -5 VDC or +/- 5 VDC)
- single ended or differential measurements
- 2 analog outputs (0 - 5 VDC 12-bit VER A, 10-Bit PWM VER B)
- 16-bit contact or TTL input event counter
- 8 digital I/O lines individually programmable as input or output
- high current digital I/O lines (sink 20mA/source 20mA)
- on-board RS232 to RS485 converter
- daisy-chainable up to 10 boards
- daisy-chainable power supply
- low power requirements (5 volts at 40mA)
- power-up via standard wall adapter (optional)
- simple yet versatile commands
- easy to use with Visual BASIC or TURBO C programs
- compatible with all ADR2000 series interfaces

1a)THE ADR2000 RS232 INTERFACE

The ADR2000 communicates via a standard RS232 port utilizing a simple three-wire interface. The only signals used are received data (RC), transmitted data (TX) and ground (GND). Most RS232 ports use hardware handshaking (i.e. DTR, DSR, CTS, RTS) signals to control the flow of data on the port. For this reason the cable required to connect to the ADR101 must have jumpers on the DB25 end to satisfy these handshaking requirements. IBM or compatible computers may be used as a host computer with the supplied cable. The supplied cable has the following connections;

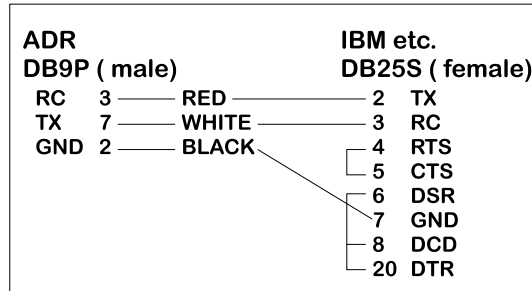

Figure 1: Supplied Cable Wiring Diagram

If the host computer has a 9-pin serial port connector, a 9-pin to 25-pin adapter cable will be required to connect to the ADR2000 cable. This adaptor is available at most computer dealers. If desired, the DB25 connector on the supplied cable may be removed and a female DB9S connector can be soldered in its place using the following wiring diagram;

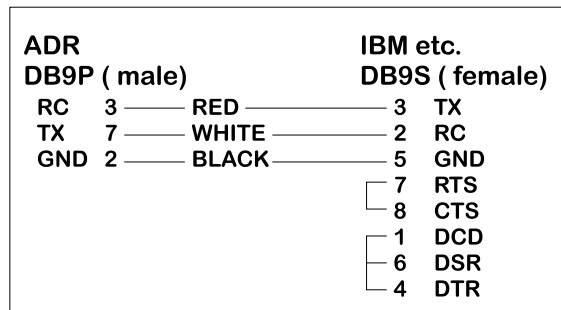

Figure 2 : Modified Wiring Diagram For 9-PIN SERIAL PORTS

If the host computer has a female DB25 connector, a male-to-male adapter is required to use the supplied cable. This may be purchased at most computer dealers. Apple Macintosh computers may be connected to the ADR2000 using MAC to DB25 DTE conversion cable. Once connected to the RS232 based host computer or terminal, the RS232 port should be configured to the following specifications to allow communication with the ADR2000.

9600 baud - 8 bit words - 1 stop bit - no parity

If using BASIC or C consult the appropriate section in this manual for details on how to configure your serial port. If a terminal or terminal emulation program is used, configure your terminal to the above specifications using the operations manual for your terminal equipment or terminal emulation program.

1b)THE ADR2000 RS485 INTERFACE

The ADR2000 RS485 interface is a two-wire connection meeting all the standards of the EIA RS485 interface specifications. The supplied cable is **NOT** an RS485 cable. To communicate via RS485 the host computer must have an RS485 port and be connected directly with two wires (TR+ and TR-). A typical connection diagram is shown in figure 2.

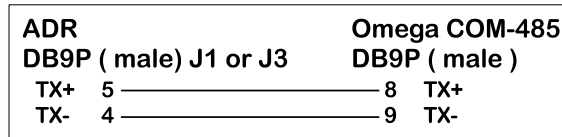

Figure 2 :Typical RS485 Connection

Note that both J1 and J3 are RS485 compatible ports. Connection from the host to the ADR2000 should be made using J1 and then J3 is used to enable daisy chaining additional ADR2000 series products.

The host RS485 port should be configured with the following specifications to enable communications to the ADR2000, 9600 Baud - 8 bit words - 1 stop bit - no parity. Line feeds should **NOT** be sent after commands as they may collide with data being returned from the ADR2000.

2.PROVIDING POWER TO THE ADR2000

The ADR2000 may be powered using a regulated 5 volt power supply or a suitable wall adaptor. Power to daisy chained ADR2000 may also be supplied via the daisy chain cable. See the Daisy chaining section of this manual for further information.

POWER-UP USING A 5 VOLT REGULATED SUPPLY

If the ADR2000 is to be powered using a regulated 5 volt power supply, the 5VDC and GND connections are to be made to the ADR2000 via the main terminal block TB1. The supply must be able to provide a minimum of 60mA and up to 240mA if the ADR2000 is to source current from the digital outputs. **Care must be taken to avoid improper power supply connection as permanent damage to the ADR2000 may result if connected improperly.** No connection to J2 is to be made if the ADR2000 is powered by a regulated 5 volt supply.

POWER-UP USING A WALL ADAPTOR

The ADR2000 has an on-board 5 volt regulator allowing the use of a 9-volt wall adaptor to power the internal circuits. The regulator should be able to provide from 300-500mA .(MODE 68-950-1) The regulator must have a standard 2.1mm, center negative, coaxial connector. The connector can then be inserted into J2 on the ADR2000. When the ADR2000 is powered by a wall adaptor, the on-board regulator also may provide a regulated 5 volts DC out to provide power to external circuits. This 5 volt supply is available on TB1. The amount of current available depends on the amount of current sourced by the digital ports. **For safe operation no more than 100mA should be drawn from the power terminals to power external circuits.**

ANALOG INPUT COMMAND SUMMARY

RD	Returns status of all 8 analog inputs in decimal format (0 - 5VDC Ref.
RB	Returns status of all 8 analog inputs in decimal format (+/- 5VDC Ref.
RDn	Returns status of analog port specified by n in decimal format. Input range 0 - 5VDC, single-ended (n = 0 to 7)
RBn	Returns status of analog port specified by n in decimal format. Input range +/- 5VDC, single-ended (n = 0 to 7)
RAn	Returns status of differential port specified by n in decimal format Input range 0 - 5VDC, differential (n = 0 to 7)
RCn	Returns status of differential port specified by n in decimal format Input range +/- 5VDC, differential (n = 0 to 7)

ANALOG OUTPUT COMMAND SUMMARY

VAdddd	Outputs decimal data (dddd) as analog voltage on Terminal V1 (0000 = 0VDC, 4095 = 5VDC) (Version A Only)
VBdddd	Outputs decimal data (dddd) as analog voltage on Terminal V2 (0000 = 0VDC, 4095 = 5VDC) (Version A Only)
FH	Sets frequency for PWM outputs to 9.76Khz (Version B Only)
FM	Sets frequency for PWM outputs to 2.44Khz (Version B Only)
FL	Sets frequency for PWM outputs to 610 Hz (Version B Only)
EA	Enables 10-bit PWM output on Terminal V1 (Version B Only)
EB	Enables 10-bit PWM output on Terminal V2 (Version B Only)
DA	Disables 10-bit PWM output on Terminal V1 (Version B Only)
DB	Disables 10-bit PWM output on Terminal V2 (Version B Only)
TAdddd	Sets period of PWM module A (Version B only)
TBdddd	Sets period of PWM module B (Version B only)

DIGITAL COMMAND SUMMARY

CPAxxxxxxx	Configures PORT A. (x=1 for input, x=0 for output)
SPAxxxxxxx	Output binary data to PORT A. (x=1 or 0)
RPA	Returns status of all I/O lines in PORT A in binary format.
RPA n	Returns status of I/O line specified by n. (n= 0 to 7)
MAddd	Outputs decimal data (ddd) to PORT A. (ddd= 0 to 255)
PA	Returns status of PORT A in decimal format.
RESPAn	Resets I/O line specified by n in PORT A. (n= 0 to 7)
SETPAn	Sets I/O line specified by n in PORT A. (n= 0 to 7)

EVENT COUNTER COMMAND SUMMARY

CE	Clear Event Counter.
RE	Returns present count of counter.
REC	Returns present count of counter and clears event counter.

ID COMMAND

*IDN?	Returns 4 digit product identifier code.
-------	--

3. ADR2000 COMMANDS

a) ANALOG INPUT COMMANDS

There are 8 analog inputs, with a resolution of 12-bits, on the ADR2000 labeled AN0 to AN7. The analog input range is 0 to 5 VDC or +/- 5VDC. The input range is automatically selected by the command used to read a specific port. Measurements may also be single-ended or differential which is selected by the command used to read a specific port. No jumpers need to be set and all analog inputs may have positive or negative voltages present whether they are read in unipolar or bipolar mode.

Single-ended input commands;

RD Reads all eight analog inputs in unipolar mode (0-5VDC) and returns 8 values in decimal format. Data separator is space (20HEX) returning 40 characters total. Order is AN0 to AN7 (voltage = (reading / 4095) X 5)

example; RD<cr>
3456 4095 1287 3212 2865 3577 1000 2321
(AN0=3456 (4.219V), AN1=4095 (5.00V), AN2=1287 (1.571V),etc.)

RDn Returns status of analog port specified by n in decimal format. (n = 0 to 7)
(Input voltage range used for conversion 0 to 5VDC)

example; RD0<CR>
2356
(AN0 =2.877V)

RB Reads all eight analog inputs in bipolar mode (+/-5VDC) and returns 8 values in decimal format. Data separator is space (20HEX) returning 40 characters total. Order is AN0 to AN7 (voltage = ((reading/4095) X 10) -5)

example; RB<cr>
3476 0023 1256 3210 1265 4095 0000 3541
(AN0=3476 (3.488V), AN1=0023 (-4.934V), AN2=1256 (-1.932V),etc.)

RBn Returns status of analog port specified by n in decimal format. (n = 0 to 7)
(Input voltage range used for conversion is (-5) to 5 VDC)

example; RB3<CR>
1866
(AN3 = - 0.443V)

Differential input commands;

Note; The analog inputs are grouped into 4 pairs for differential measurements. They are; AN0 and AN1, AN2 and AN3, AN4 and AN5, AN6 and AN7. In differential commands (n) may be any number from 0 to 7 and specifies which input is to be considered the positive input for a differential measurement. Ex RA1 reads the difference between AN0 and AN1 with AN1 being

the positive input. RA0 reads the same pair but uses AN0 for the positive reference.

RA_n Returns status of differential analog port specified by n in decimal format.
(n = 0 to 7) (Input voltage range used for conversion 0 to 5VDC)

example; RA0<CR>
1056

To convert to voltage; voltage = (reading/4095) * 5
Ex. Diff between AN0 and AN1 is at (1056/4095) * 5 volts= 1.2894 volts

RC_n Returns status of differential analog port specified by n in decimal format. (n = 0 to 7)
(Input voltage range used for conversion is (-5) to 5 VDC)

example; RC3<CR>
1866

To convert to voltage; voltage = ((reading/4095)*10) - 5
Ex. Diff between AN3 and AN2 is at ((reading/4095)*10) - 5 = (- .4432 volts)

b) ANALOG OUTPUT COMMANDS

The ADR2000 has two analog outputs on terminals V1 and V2. The outputs are either 12-bit, 0-5VDC analog outputs (**Version A**) or 10-bit PWM outputs (**Version B**)

Version A (12-bit, 0 to 5VDC analog voltage outputs)

VA_{dddd} Sets voltage output on Terminal V1 (dddd = 0000 to 4095)

example; VA2399<CR>

output voltage on V1 is set to (2399/4095)*5 = 2.929VDC

VB_{dddd} Sets voltage output on Terminal V2 (dddd = 0000 to 4095)

example; VB3766<CR>

output voltage on V2 is set to (3766/4095)*5 = 4.598VDC

Version B (10-bit PWM outputs)

The PWM modules on Version B ADR2000 boards can operate at three fixed output frequencies. Both modules must operate at the same frequency and this frequency is set by the FH,FM and FL commands

FH Sets frequency for PWM outputs to 9.76Khz

FM Sets frequency for PWM outputs to 2.44Khz

FL Sets frequency for PWM outputs to 610.Hz.

Note: if frequency is not set, default frequency is 610 Hz.

EA Turns on PWM output to Terminal V1
EB Turns on PWM output to Terminal V2
DA Disables PWM output on Terminal V1 (V1 = high impedance)
DB Disables PWM output on Terminal V2 (V2 = high impedance)

Note1: When PWM pins are disabled they are put into high impedance state.

TAdddd Sets the period of PWM output A on terminal V1 (dddd=0000 to 1024)
(0000 = 0% 1024 = 100%)

example; TA512<CR>

period is set to 512/1024 = 50%

TBdddd Sets the period of PWM output B on terminal V2 (dddd=0000 to 1024)
(0000 = 0% 1024 = 100%)

example; TB232<CR>

period is set to 232/1024 = 22.65%

c) DIGITAL PORT COMMANDS

There is one, eight bit digital port on the ADR2000 labeled PORT A. The individual I/O lines are labeled PA0-PA7. The following commands allow the user to;

- configure individual bits an input or output
- SET or RESET individual bits
- read individual bits
- read entire port in binary or decimal format
- write to entire port in binary or decimal format.

The digital port commands are;

CPAxxxxxxx Configures each bit of PORT A . All eight bits must be specified. Order is MSB-LSB (x=1 for input, x=0 for output)

example; CPA11110000<CR>

(PA7 ,PA6, PA5, PA4 are configured as inputs and PA3, PA2, PA1, PA0 are configured as outputs)

SPAxxxxxxx Outputs binary data to PORT A. All eight bits must be specified. Order is MSB-LSB. Individual bits configured as input are not effected by this command. (x=1 or 0)

example; SPA10101000<CR>

(PA7, PA5, PA3 are set, PA6, PA4, PA2, PA1, PA0 are reset)

RPA Returns status of all I/O lines in PORT A in binary format. Order is MSB-LSB. Individual lines configured as output will return last data set on the port.

example; RPA<CR>

0 1 1 1 0 0 1 0
(PA7, PA3, PA2, PA0 are low, PA6, PA5 ,PA4, PA1 are high)

RPA_n Returns status of I/O line in PORT A specified by n.(n=0 to 7)

example; RPA4<CR>
1
(PA4 is high)

MA_{ddd} Outputs decimal data (ddd) to PORT A. Individual lines configured as input are not effected by this command. (ddd= 000 to 255)

example; MA255<CR>

(All lines of PORT A are set)

PA Returns status of PORT A in decimal format. Individual lines configured as output will return last data set on PORT A.

example; PA<CR>
128
(PA7 is high, PA6 thru PA0 are low)

RES_{PA}_n Resets I/O line specified by n in PORT A. This command has no effect on I/O lines configured as input. (n=0 to 7)

example; RESPA4<CR>
(PA4 is reset)

SET_{PA}_n Sets I/O line specified by n in PORT A. This command has no effect on I/O lines configured as input. (n=0 to 7)

example; SETPA3<CR>
(PA3 is set)

d) EVENT COUNTER COMMANDS

The ADR2000 is equipped with a 16-bit event counter that accepts TTL or contact input. There are three commands available to read, and clear the event counter. If the maximum count of 65535 is reached the counter will rollover to 00000 .

RE Returns decimal value of event counter

example; RE<CR>
00456
(Present count is 456.)

CE Clears event counter

example; CE<CR>
(Event counter is cleared to 00000)

REC Reads and clears event counter

example; REC<CR>
12034
(Count is returned (12034) and counter is reset to 00000.)

E) ID COMMAND

*IDN? _____ Returns ID code (Version A returns 2000, Version B returns 2001)
_____ * may be omitted

4.SENDING COMMANDS IN BASIC TO THE ADR2000

OPENING A SERIAL FILE

Commands may be sent to the ADR2000 using a terminal emulation program such as Hyperterminal by simply entering commands and pressing <cr>. With BASIC, the ADR2000 is connected to the computer via a serial cable and BASIC treats the ADR2000 as a serial file. Before commands can be sent to the ADR2000 this serial file must be opened and initialized. This should be done at the start of any program that is to access the ADR2000. The command to open a serial file is shown below;

```
10 OPEN "COM1:9600,n,8,1,CS,DS,RS" AS#1
```

This line opens a serial file and labels it as serial file #1. This allows access to the ADR2000 using PRINT#1 and INPUT#1 commands.

SENDING COMMANDS

Sending commands in BASIC to the ADR2000 can be done using PRINT#1 commands. For example, sending an RD0 command could be done as shown below;

```
20 PRINT#1, "RD0"
```

Extra spaces inside the quotes are ignored by the ADR2000. Avoid sending commands on consecutive lines because a <CR> is not sent after the first command resulting in an unrecognized command. This problem arises with the configuring of a digital port and then trying to access the port immediately after it is configured. A REM statement should be inserted between consecutive PRINT#1 commands as shown below;

```
20 PRINT#1, "CPA00000000"  
30 REM FORCES <CR>  
40 PRINT#1, "SETPA0"
```

Variable names may also be used with PRINT#1 commands. One example of this shown below. This program configures PORT A as output and the increments it from 0 to 255.

```
10 OPEN "COM1:9600,n,8,1,CS,DS,RS" AS#1  
20 PRINT#1, "CPA00000000"  
30 FOR X = 0 to 255  
40 PRINT#1, "MA",X  
50 NEXT X  
60 END
```

RECEIVING DATA

When reading analog inputs or the digital port, data is sent from the ADR2000 to the host computers serial buffer. This data can be retrieved using INPUT#1 commands. The INPUT#1 command should be used following PRINT#1 commands if data is expected to be sent by the ADR2000. If a single piece of data is expected then one variable name should be used with the INPUT#1 command. If eight pieces of data are to be received as with the RPA command then eight variable names must be used with the INPUT#1 command. Examples of both cases are shown below;

```

20 PRINT#1, "RA0"
30 INPUT#1, ANADAT
40 PRINT#1, "RPA"
50 INPUT#1, PA7,PA6,PA5,PA4,PA3,PA2,PA1,PA0

```

The variable names used in the INPUT#1 commands now contain the data sent by the ADR2000
The data can now be scaled, printed, displayed, saved or whatever is required by the application.

A BASIC PROGRAM EXAMPLE

A complete BASIC program which reads analog port 0 and sets PA0 if the analog port is above decimal value 2048 (2.5 volts) is shown below;

```

10 OPEN "COM1:9600,n,8,1,CS,DS,RS" AS#1           ;opens and configures serial file
20 PRINT#1, "CPA11111110"                         ;configures PA0 as output
30 REM FORCES <CR>
40 PRINT#1, "RESPA0"                               ;resets PA0
50 REM FORCES <CR>
50 PRINT#1, "RD0"                                  ;sends RD0 command
60 INPUT#1, AN0                                    ;receives data into variable AN0
70 IF AN0>2048 then PRINT#1, "SETPA0":GOTO 50      ;sends SETPA0 command if
                                                    AN0>50% and returns to line 50
80 PRINT#1, "RESPA0" : GOTO 50                    ;resets PA0 and returns to 50

```

Visit our web page at www.ontrak.net for additional programming examples in BASIC, Visual Basic and C.

5) SENDING COMMANDS IN TURBO C TO THE ADR2000

This section will demonstrate how to send and receive data from the ADR2000 using TURBO C. It outlines the commands used to, configure the serial port (bioscom), send data out through the serial port (fprintf), and receive data through the serial port (fscanf).

Commands used in TURBO C to access the ADR2000 require the following include files to be declared at the start of TURBO C programs;

```

#include <stdio.h>
#include <bios.h>

```

CONFIGURING THE SERIAL PORT

The first step in accessing the ADR2000 via the serial port is configuring the serial port to the proper communication parameters which are, 9600 baud, 8 bit words, no parity. This is done using the "bioscom" command. The syntax for this command is;

```

bioscom (0,settings,com1);

```

where settings is previously defined as HEX E3 and com1 is defined as 0. Defining "settings" and "com1" should be done using;

```

#define com1 0
#define settings (0xE3)

```

These statements should be placed immediately following your include files (see programming examples). The bioscom command needs only to be executed once before the ADR2000 is accessed.

SENDING COMMANDS TO THE ADR2000

To send commands to the ADR2000 the "fprintf" command is used. For example, the following command sends an RD0 (read analog port 0) command to the ADR2000;

```
fprintf (stdaux,"RD0 \xD");
```

The \xD suffix sends a carriage return after the command which is needed by the ADR2000 to recognize a command. Integer variables may also be used in the command line. For example, the following command sends a MAddd (make port A=ddd) command, where DOUT is a previously defined integer value of 0 to 255.

```
fprintf (stdaux,"MA %d \xD",DOUT);
```

RECEIVING DATA FROM THE ADR2000

If a command sent to the ADR2000 is a responsive command, that is, one that results in data being sent back to the host, the data is retrieved using the "fscanf" command. After this command is used the serial buffer must be re-initialized using the "rewind" command. The syntax for this command is;

```
rewind (stdaux);
```

This command is executed after data is retrieved using the "fscanf" command. For example, the following commands send a RD0 command and stores the retrieved data in an integer variable named AN0;

```
fprintf (stdaux,"RD0 \xD");  
fscanf (stdaux,"%D",&an0);  
rewind (stdaux);
```

In this example, the command PA (read port A) is sent to the ADR2000 and the retrieved data is stored in an integer variable named PORTA;

```
fprintf (stdaux,"PA \xD");  
fscanf (stdaux,"%D",&PORTA);  
rewind (stdaux);
```

The following test programs outline the proper syntax for using the commands in simple applications. The first program retrieves the status of analog port 0 and displays the data on the video screen. The second program configures PORT A as output, sets the port to decimal 255, reads back the port status and displays the data on the video screen.

```
/* PROGRAM EXAMPLE ONE - ANALOG PORT TEST PROGRAM */
```

```
#include <stdio.h>
#include <bios.h>
#define com1 0
#define settings (0xE3)

main( )
{
    /* declare an0 as an integer number */
    int an0 ;
        /* configure com1 9600 baud, 8 bit words, no parity */
    bioscom (0,settings,com1);
        /* send RD0 command to ADR2000 on com1 */
    fprintf(stdaux,"RD0 \xD");
        /* read data from com1 and store it at address of an0 */
    fscanf (stdaux,"%d",&an0);
        /* initialize com1 buffer */
    rewind (stdaux);
        /* print data on screen */
    printf ("ANALOG PORT 0= %d \n",an0);
}
```

```
/* PROGRAM EXAMPLE TWO - DIGITAL PORT TEST PROGRAM */
```

```
#include <stdio.h>
#include <bios.h>
#define com1 0
#define settings (0xE3)

main ( )
{
    /* declare PORTA and DOUT as integer numbers */
    int PORTA,DOUT ;
        /* set DOUT to integer 255 */
    DOUT=255;
        /* configure com1 9600 baud, 8 bit words, no parity */
    bioscom (0,settings,com1);
        /* send CPA00000000 command to ADR2000 on com1 */
    fprintf (stdaux,"CPA00000000 \xD");
        /* send MAddd (ddd=DOUT) command to ADR2000 on com1 */
    fprintf (stdaux,"MA %d \xD",DOUT );
        /* send PA command to ADR2000 on com1 */
    fprintf (stdaux,"PA \xD");
        /* read data from com1 and store at address of PORTA */
    fscanf (stdaux,"%d",&PORTA );
        /* initialize com1 buffer */
    rewind (stdaux);
        /* print data on screen */
    printf ("PORT A is %d DECIMAL \n",PORTA);
}
```

6. Daisy Chain Options for the ADR2000

Daisy chaining ADR2000 series boards involves three steps.

- A. Setting Address Jumpers
- B. Physically Connecting Boards
- C. Sending commands

A. Setting Address Jumpers

The ADR2000 can be daisy-chained, regardless of the type of serial interface provided by the host computer. Each board on the chain must be assigned an address via the BCD address jumper block on the ADR2000. Up to ten boards may be daisy-chained. The following table shows how to jumper the address jumper block to select a board address.

Position 8	Position 4	Position 2	Position 1	Address
OPEN	OPEN	OPEN	OPEN	0
OPEN	OPEN	OPEN	JUMP	1
OPEN	OPEN	JUMP	OPEN	2
OPEN	OPEN	JUMP	JUMP	3
OPEN	JUMP	OPEN	OPEN	4
OPEN	JUMP	OPEN	JUMP	5
OPEN	JUMP	JUMP	OPEN	6
OPEN	JUMP	JUMP	JUMP	7
JUMP	OPEN	OPEN	OPEN	8
JUMP	OPEN	OPEN	JUMP	9

Table 1. Address Jumper Settings.

B. Physically Connecting Boards

The ADR2000 series interface boards have two DB9 connectors that allow daisy chaining. The data format used in daisy chaining is RS485 regardless of the host communication type. To connect boards on a chain, a daisy chain cable must be constructed. The cable must provide two connections for the RS485 signals. A typical daisy-chain cable is shown in Figure 5a)

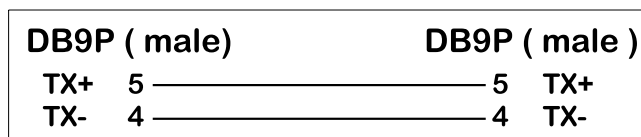

Figure 5a):

Daisy-chain cable

Power may be shared in daisy-chained ADR2000 series interfaces if two extra conductors are added to the daisy-chain cable. Care should be taken that the output current limitation on the power supply is not exceeded. The connections for a powered daisy-chain cable are shown in Figure 5B) **NOTE: Power sharing is available only if power is applied via J2 (7-15VDC).**

DB9P (male)		DB9P (male)	
TX+	5	5	TX+
TX-	4	4	TX-
+9VDC	6	6	+9VDC
GND	1	1	GND

Figure 5b) : Powered Daisy-Chain Cable

The Daisy-chain cable can be connected from J3 to either J1 or J3 on additional ADR2000 interfaces. Both J1 and J3 have identical pinouts for RS485 and power signals used for daisy-chain applications. Figure 5c) shows a typical daisy-chain application. If a Powered daisy-chain cable is

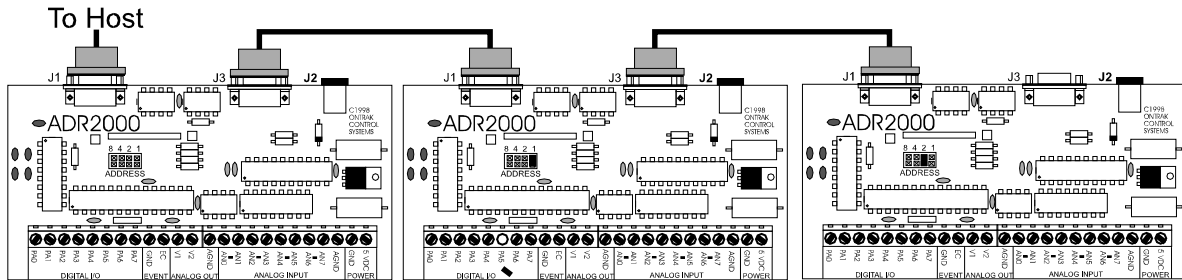

used, power need only be connected to J2 on any one ADR2000 in the chain.

Figure 5c) Typical Daisy-Chain Application

C Sending Commands

Once a board is jumpered, it will respond only to commands preceded by its address as a single digit integer number. For example to read analog port 0 on board 3 the command "3RD0"<cr> is sent. To set PA4 on board 7 the command "7SETPA4",cr> is sent. Spaces sent between the board address and commands are ignored. Board zero will respond to both commands with no preceding address and commands preceded with a zero for reasons of continuity. Never connect two boards with the same address on the same chain. This will result in both boards responding at the same time and will cause contention on the network with possible damage to the ADR boards.

7. Interfacing to the ADR2000 (Basic Examples)

The following interface examples show basic examples of interfacing various devices to the ADR2000. Sample programs are written in BASIC and demonstrate proper command syntax.

A) Reading Potentiometer Position

To monitor potentiometer position, the potentiometer must be biased with 5VDC. The wiper of the pot is then connected to one of the analog inputs. The sample BASIC program reads the potentiometer position using the RD0 command which responds with a decimal value between 0000 and 4095. The value is then converted to a percent and displayed on the video screen.

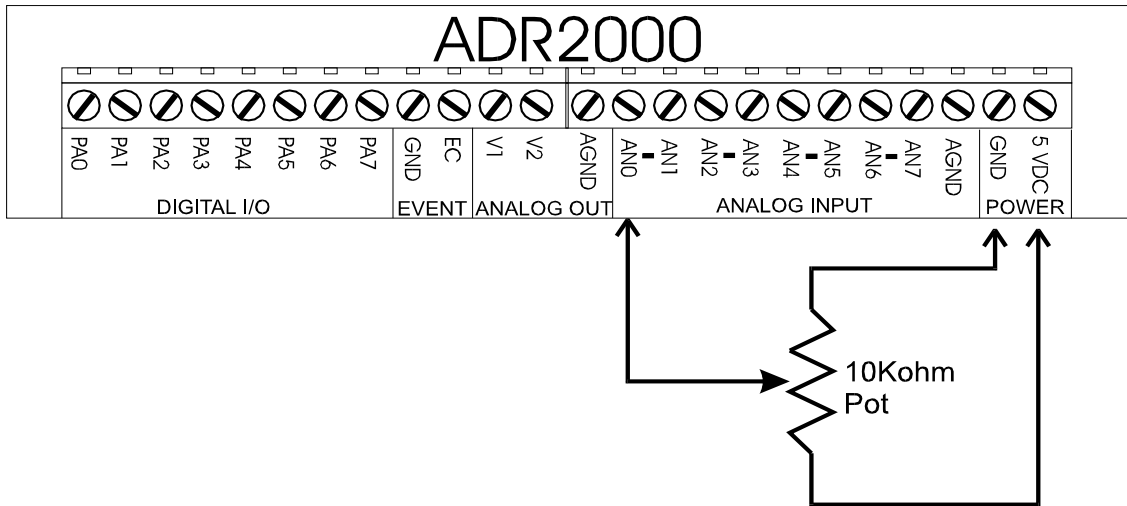

```

10 OPEN "COM1:9600,N,8,1,CS,DS,RS" AS#1
20 CLS
30 LOCATE 1,1
40 PRINT#1, "RD0"
50 INPUT#1, POT
60 POT=(POT/4095)*100
70 PRINT "Potentiometer Position is", POT
80 GOTO 30

```

```

;open com port
;clear screen
;locate cursor
;send RD0 command to ADR2000
;retrieve data from ADR2000
;convert data to percent
;display it
;repeat procedure

```

B) Connecting Switches to Digital Ports

To connect switches to digital I/O lines only one additional component is required. Each digital input line used to read a switch must be tied to +5V via a 10Kohm resistor. This is to avoid leaving the digital port floating when the switch is in the open position. The switch is then connected between the digital port and ground. The sample BASIC program first configures the digital I/O lines as input and then reads the switches and displays their status on the video screen.

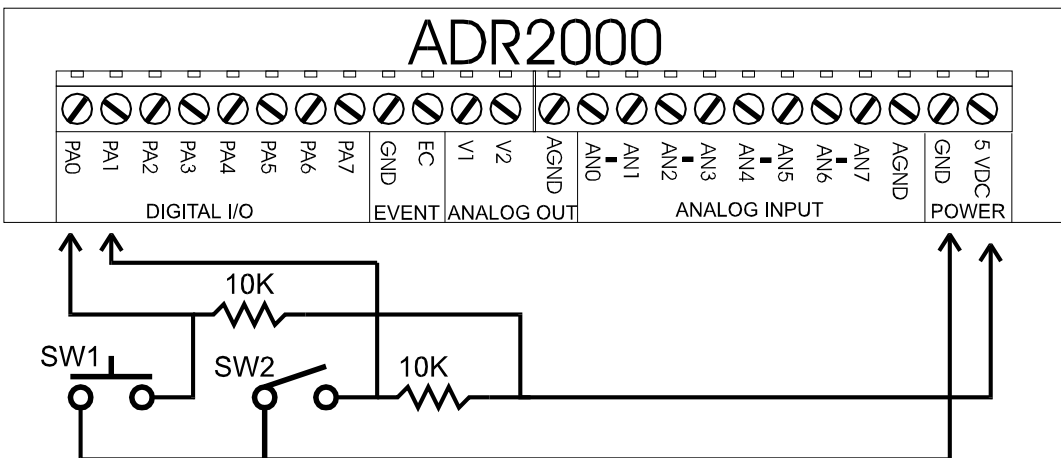

```

10 OPEN "COM1:9600,N,8,1,CS,DS,RS" AS#1
20 CLS
30 LOCATE 1,1
40 PRINT#1, "CPA11111111"
50 REM
60 PRINT#1, "RPA0"

```

```

;opens com port
;clears screen
;locates cursor
;configures port as input
;forces <CR>
;reads PA0 ( SW 1 )

```

```

70 INPUT#1, SW1 ;saves status in variable SW1
80 PRINT#1, "RPA1" ;reads PA1 ( SW2 )
90 INPUT#1,SW2 ;saves status in variable SW2
100 T1$="CLOSED" IF SW1=1 THEN T1$="OPEN " ;define T1$
110 T2$="CLOSED" IF SW2=1 THEN T2$="OPEN " ;define T2$
120 PRINT "SW1 is " T1$ ;print SW1 status
130 PRINT "SW2 is " T2$ ;print SW2 status
140 GOTO 60 ;repeat procedure

```

C) Connecting LED's to Digital Ports

LED's may be controlled using the digital I/O lines on the ADR2000. Only one additional component is needed to drive LED's. A current limit resistor is required for each LED with a value of around 220 Ohms. The LED is turned on by resetting PA0 to a logic zero or turned off by setting PA0 to a logic one. The sample BASIC program demonstrates how to turn the LED on and off.

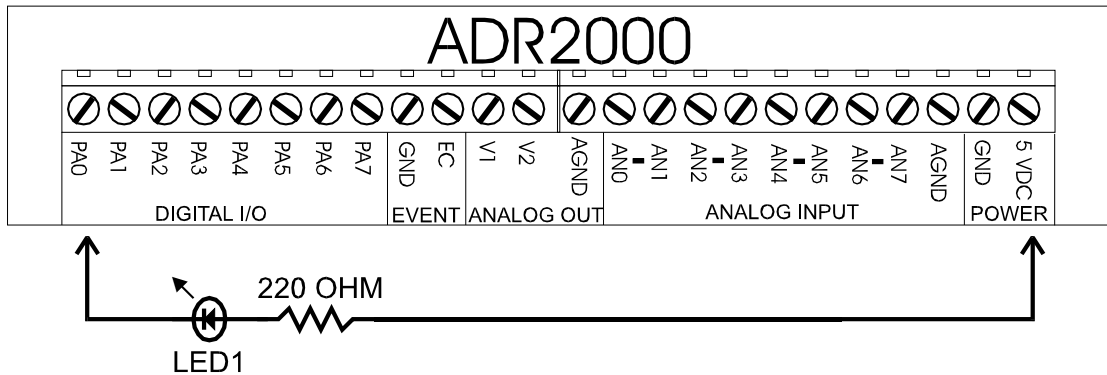

```

10 OPEN "COM1:9600,N,8,1,CS,DS,RS" AS#1 ;opens com port
20 CLS ;clears screen
30 PRINT#1, "SETPA0" ;sets PA0*
40 REM ;forces <cr>
50 PRINT#1, "CPA11111110" ;configures PA0 as output
60 REM Turn on LED ;forces <cr>
70 PRINT#1, "RESPA0" ;turns on LED
80 REM Turn off LED ;forces <cr>
90 PRINT#1, "SETPA0" ;turns off LED
100 END

```

* PA0 remains in high impedance state until the CPA command is used to configure the port as output.

D) Driving Solid State Relays

Solid-State relays that require a DC voltage to operate may be driven by ADR2000 digital I/O lines directly if the current input specification for the relay is 20mA or less. The relay must be rated for the proper voltage and current required by the load. Each relay requires one digital I/O line to operate and requires no other external components. The sample BASIC program demonstrates how the relay is turned on. Note that the I/O line is RESET before the CPA command is used to configure the port as output to avoid the relay turning on unexpectedly when the port is configured.

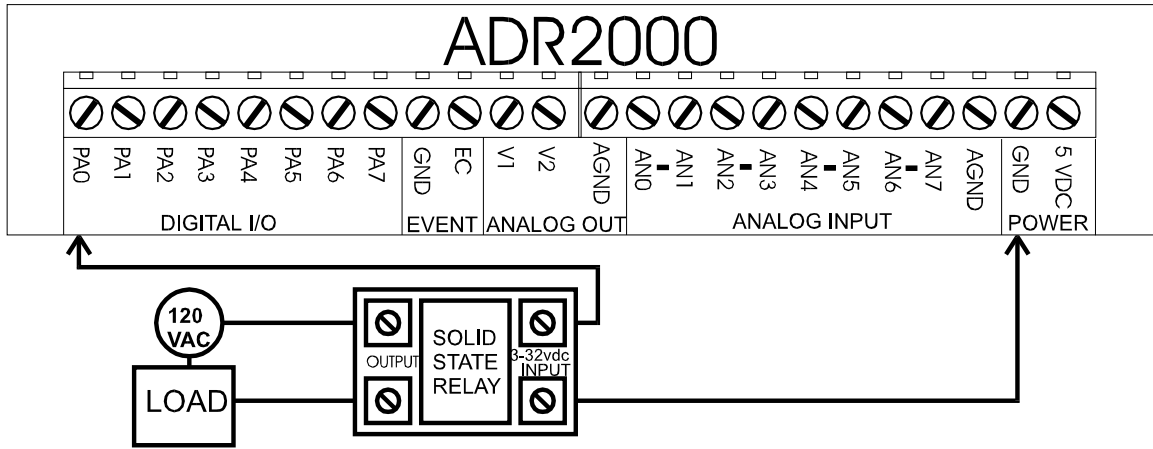

```

10 OPEN "COM1:9600,N,8,1,CS,DS,RS" AS#1           ;opens com port
20 CLS                                           ;clears screen
30 PRINT#1, "RESPA0"                             ;resets PA0
40 REM                                           ;forces <cr>
50 PRINT#1, "CPA11111110"                       ;configures PA0 as output
60 REM Turn on relay                             ;forces <cr>

70 PRINT#1, "SETPA0"                             ;turns relay on
80 REM Turn off relay                            ;forces <cr>
90 PRINT#1, "RESPA0"                             ;turns relay off

```

E) Solid-State Temperature Measurement

The LM335 is a solid-state temperature sensor with an input span of -40 to +100C. It outputs temperature 10mV per degree Kelvin. Only one external component is required to use the LM335 with the ADR2000. R1 is a 1Kohm resistor used to bias the LM335. The sample software program reads the sensor using an RD0 command, converts the result to Celsius and displays the temperature on the video screen.

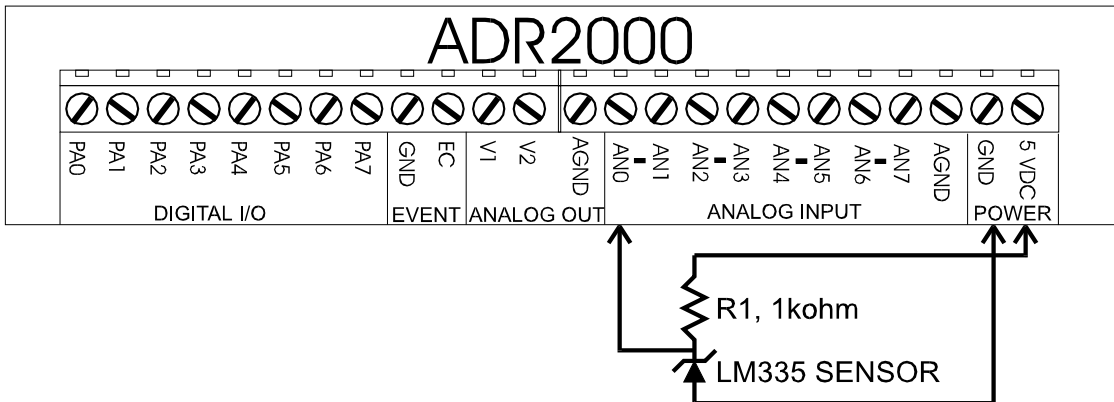

```

10 OPEN"COM1:9600,N,8,1,CS,DS,RS" AS#1           ;open com port
20 CLS                                           ;clear screen
30 LOCATE 1,1                                   ;locate cursor
40 PRINT#1, "RD0"                               ;send RD0 command to ADR2000
50 INPUT#1, READING                             ;retrieve data from ADR2000
60 TEMPERATURE=((READING/4095)*5)-2.73)*100      ;convert data to Celsius*
70 PRINT "Temperature is", TEMPERATURE          ;display it
80 GOTO 30                                       ;repeat procedure

```

* voltage is converted to Celsius by subtracting 2.73 (273K) and multiplying by 100.

F) Event Counter Connections

The event counter accepts both TTL and dry contact inputs. TTL type inputs may be connected directly to the EC input while dry contacts must be connected between GND and the EC input. Events are counted on the rising edge of the input which is when the TTL signal switches from low to high or the dry contact opens. The sample program reads the dry contact input and displays the count result continuously on the video screen

```
10 OPEN"COM1:9600,N,8,1,CS,DS,RS" AS#1           ;open com port
20 CLS                                           ;clear screen
```

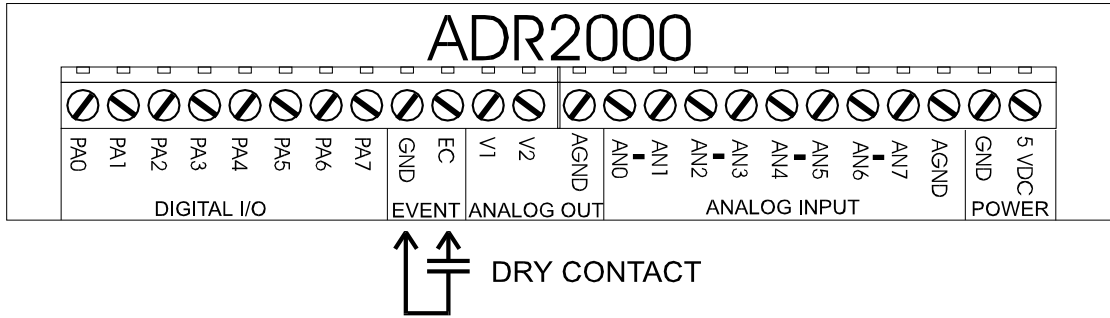

```
30 LOCATE 1,1                                   ;locate cursor
40 PRINT#1, "CE"                               ;clears event counter
50 PRINT "PRESENT COUNT IS",COUNT             ;displays count data
60 PRINT#1, "RE"                               ;sends RE command to ADR2000
70 INPUT#1, COUNT                             ;retrieves count data
80 GOTO 50                                     ;repeat procedure
```

APPENDIX A CONNECTION DIAGRAM

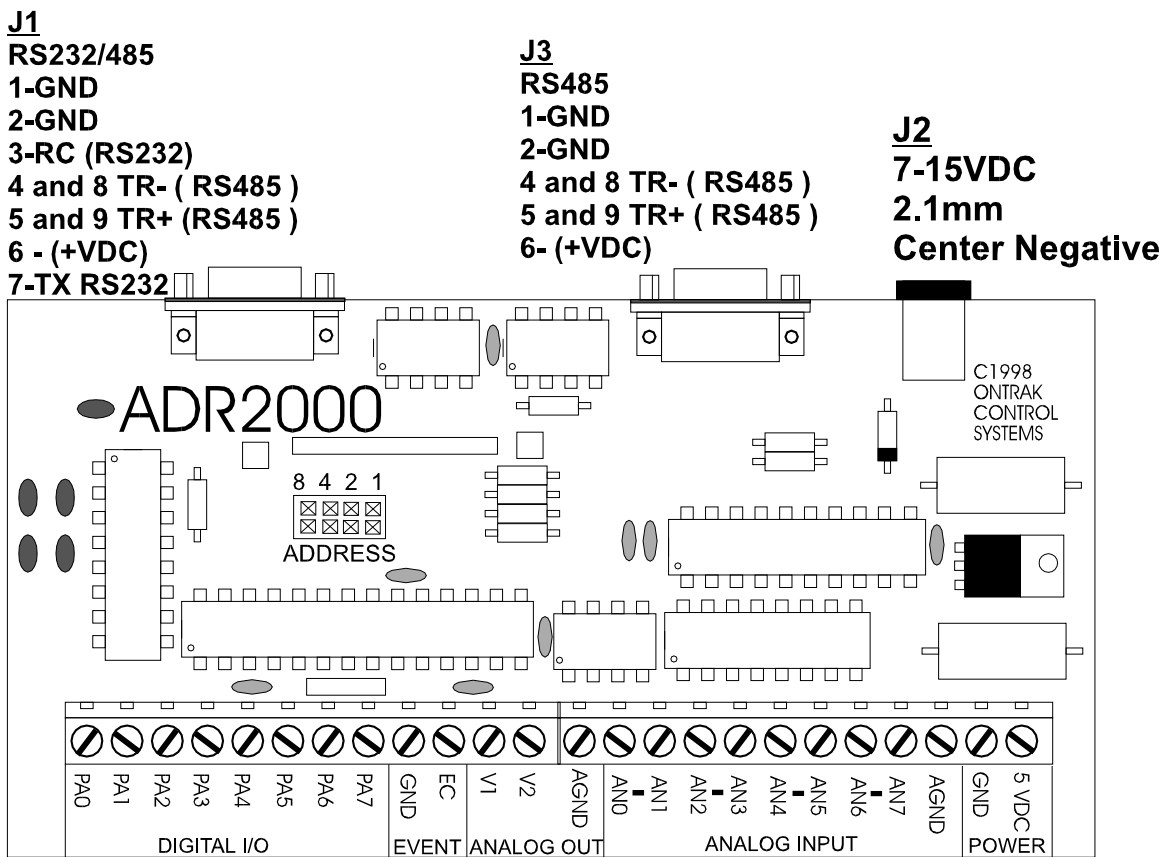

APPENDIX B ELECTRICAL SPECIFICATIONS

ADR2000 (Version A and Version B)

Supply Voltage	5VDC+/- 10% or 7-9VDC via wall adaptor
Supply Current*	40mA Typical, 60mA Maximum
Operating Temperature	0-50C

* all digital outputs unloaded

Analog Inputs (8)

Resolution	12 bits
Accuracy	0.1% uncalibrated, (.02% calibrated)
Range	0-5VDC or +/- 5VDC
Protection	OVP to +/- 15VDC
Input Impedance	1Mohm

Analog Outputs (2)

VERSION A

Type	Voltage
Resolution	12 bits
Range	0-5VDC
Output Current	5mA Maximum total of both outputs

VERSION B

Type	PWM
Resolution	10 bits
Frequency	9.76Khz, 2.44Khz, 610Hz (software selected)
Range	TTL
Output Current	Sink 20mA Maximum, Source 20mA Maximum

Digital I/O (8)

Sink Current	20mA Maximum
Source Current	20mA Maximum

Event Counter (1)

Type	TTL or Contact
Resolution	16 bits

Communication Interface

RS232 and RS485
9600 baud, 8 bit words, no parity, 1 start bit
Daisy-chain via RS485

Visit our web site at <http://www.ontrak.net/> for additional applications and programming examples.

APPENDIX C MOUNTING DIMENSIONS

