

# GAPS: An Indirect DM Search Using Anti-Deuterons

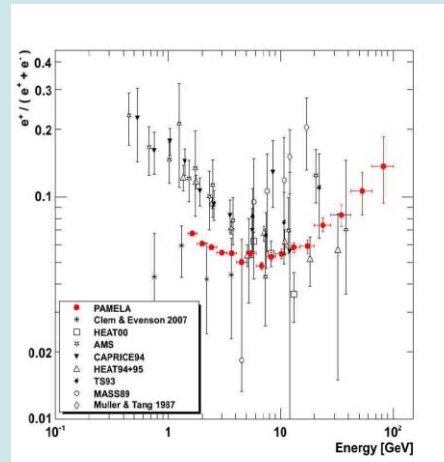

positrons ?

anti-deuterons ?

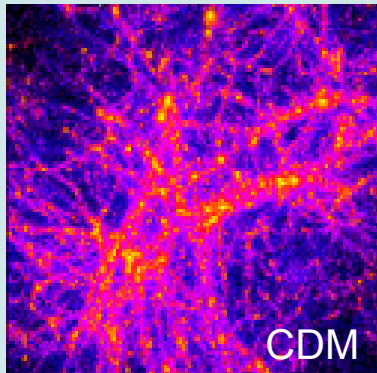
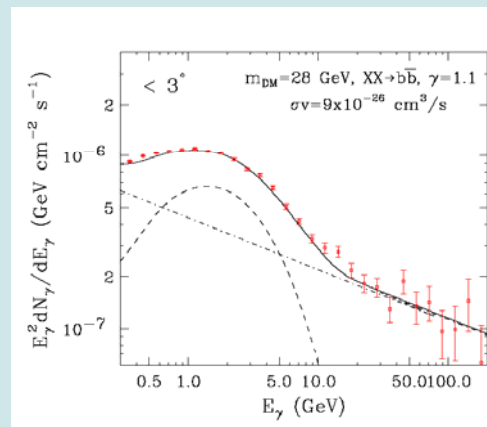
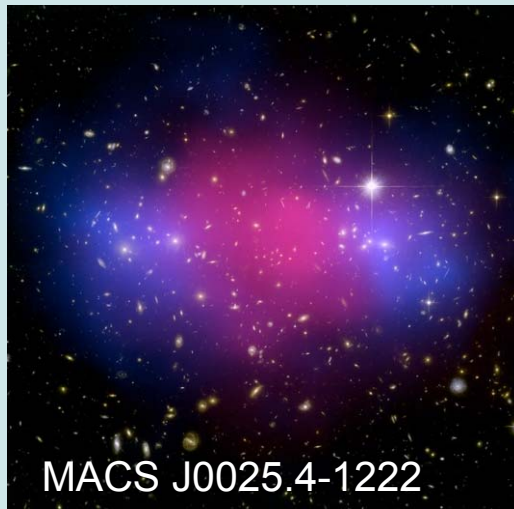
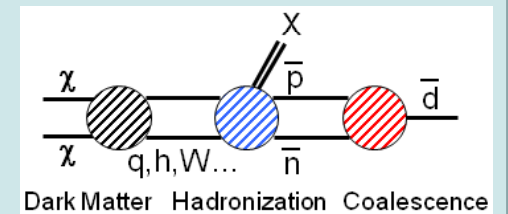

$\gamma$ -rays?

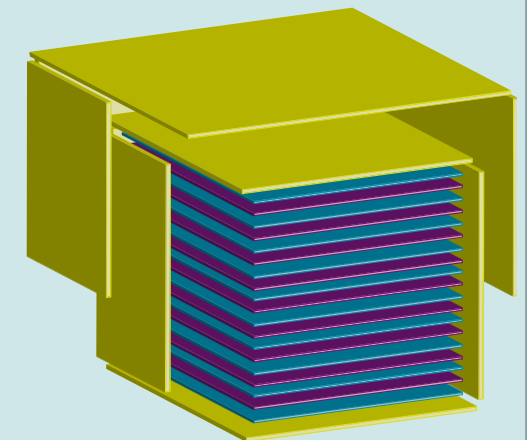

GAPS

# Outline

---

- Astrophysical particle DM and indirect detection.
- Searching for the anti-deuteron – the *why* and *how*.
- **GAPS:**  
An anti-deuteron search using a novel technique.
- Present status and future prospects for GAPS.
- **Bonus: Latest results from VERITAS on  $\gamma$ -ray signatures for DM.**

# Astrophysical Evidence & Particle DM

- Good evidence for DM since 1930's. Strengthened over time to include many types of astrophysical systems: spiral galaxies, clusters, our own MW, etc.

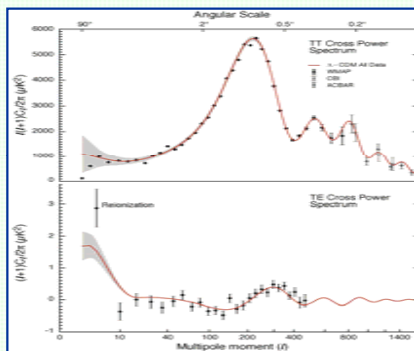

CMB  
(+ SN,  $H_0$ , etc.)

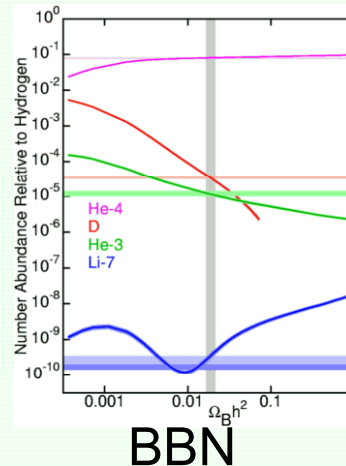

BBN

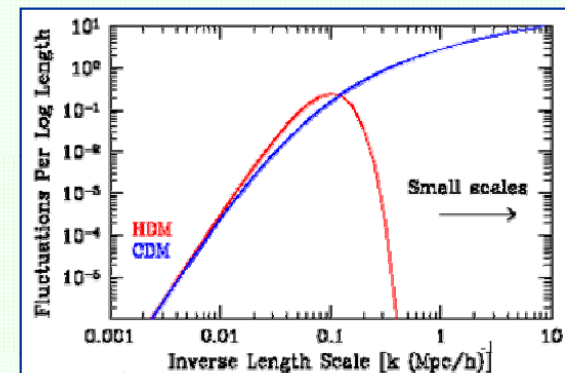

Structure

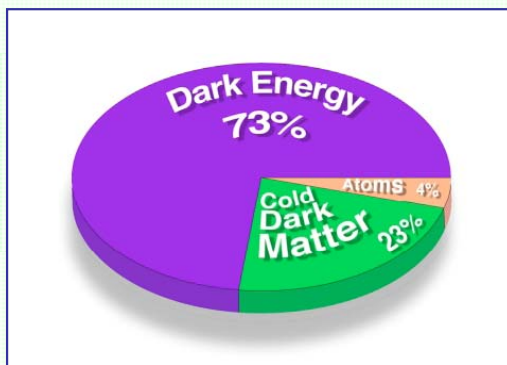

- Cosmology measurements give key insights into the nature of DM:
  1. DM is non-baryonic.
  2. DM is not hot.



# Cold DM Candidates

---

CDM hypothesis needs testing and verification

→ motivates **Grand Search for particle DM**

Various candidates, including:

- Primordial BH's.
- Axions – searches are underway.
- Weakly interacting massive particles (WIMPs).

## WIMPS:

- Attractive because present relic density is consistent with that expected for a particle with weak-scale ( $\sim$ TeV) interactions.

$$\Omega_{\chi} h^2 \approx 10^{-27} \text{ cm}^3 \text{ s}^{-1} / \langle \sigma_A v \rangle$$

implies a suitable relic density for  $\sigma_A$ ,  $m_{\chi}$  at electroweak scale.

# Bonus: “second” miracle

---

Additional motivation from particle physics to explain EWSB

→ New physics at  $\sim$ TeV scale

- This has spawned an enormous amount of theoretical activity (including this meeting!), leading to many viable candidates for CDM, including supersymmetry (WIMP=LSP), Kaluza-Klein theory (WIMP=LKP, U(1) gauge boson), etc. etc.

Experimental point of view:

New particle physics models have many parameters, none of which can be known *a priori*.

This results in:

- large uncertainty in properties of DM particle (e.g.  $\sigma$ 's).
- difficulty in placing meaningful theoretical constraints.

**(“*You’re only allowed one miracle.*”, L. Rosenberg, 1990.)**



Actually, we have no idea !

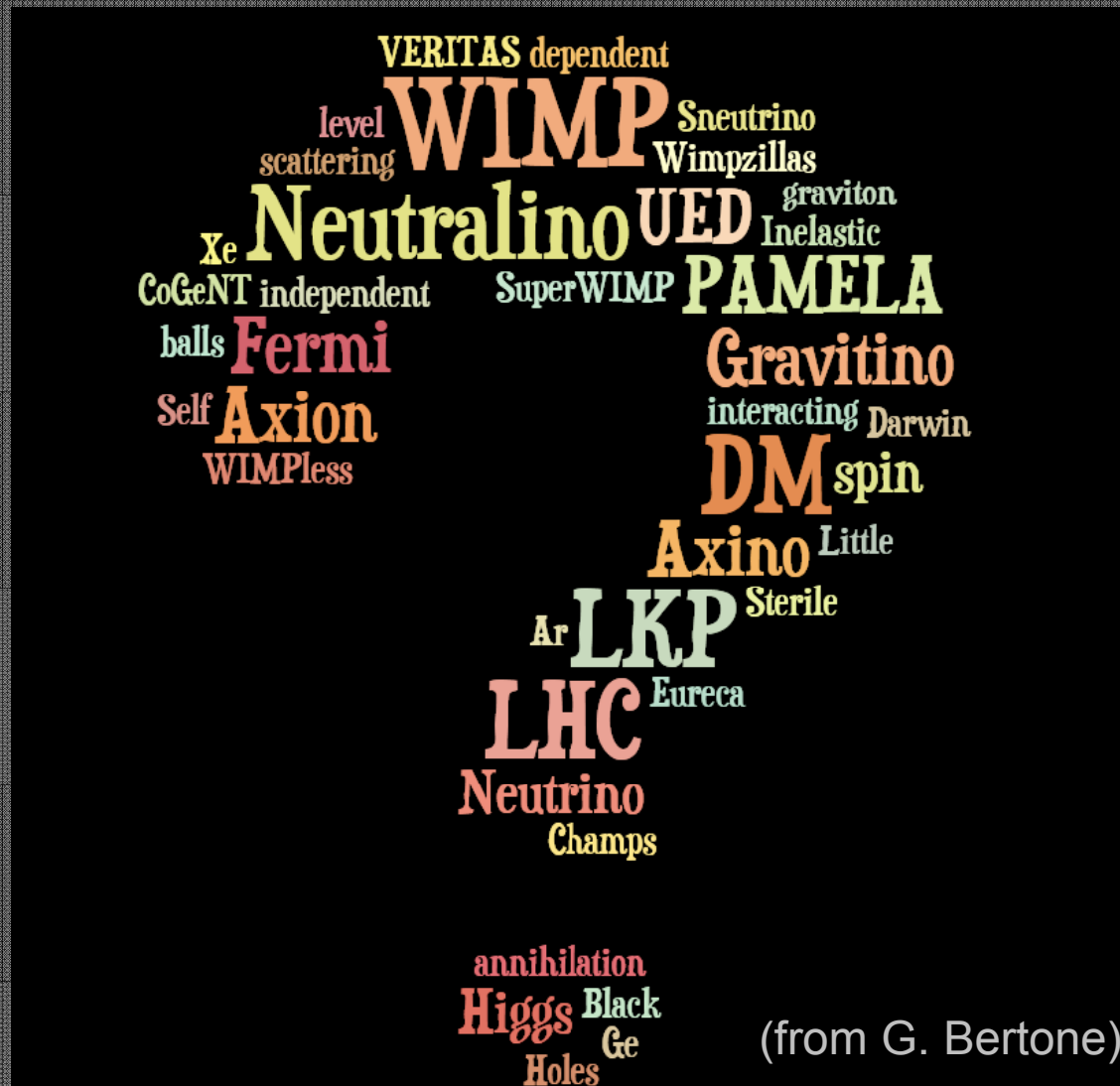

(from G. Bertone)

... and we really need to search for DM particles using any (all) possible techniques.



# DM Detection: Complementary Approaches

Produce DM particle  
in accelerators



LHC at CERN

Direct Detection

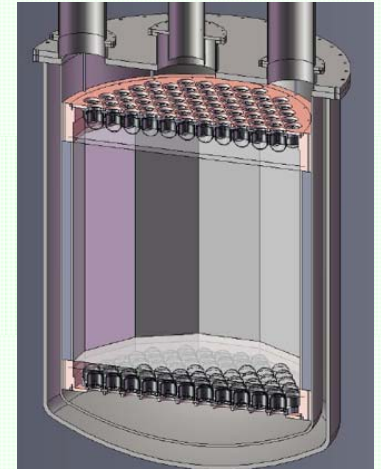
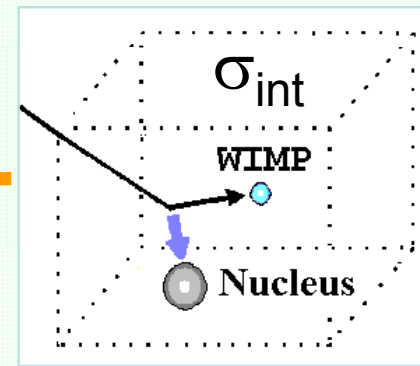

Xenon1T Detector

THEORY

Astrophysical  
Indirect  
Detection



Sextens dwarf galaxy

Annihilation ( $\sigma_A$ )

$\chi\chi \rightarrow$

$\gamma$ 's,  $\nu$ 's,  
anti-matter

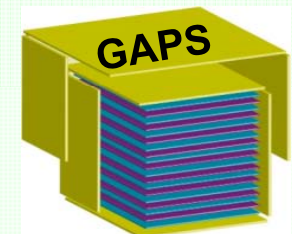

# Indirect Detection

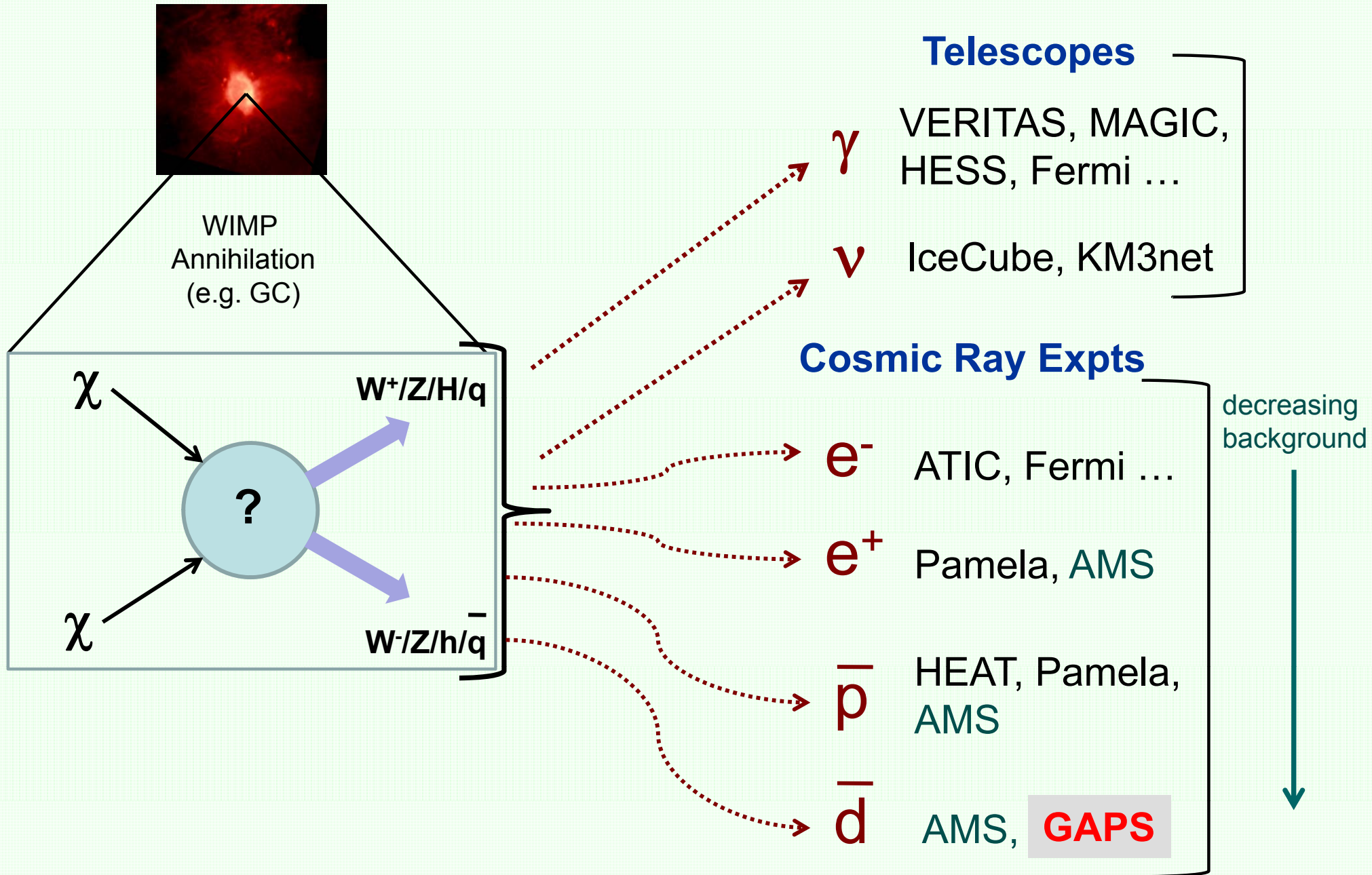



# Some Recent Indirect Results

$e^-/e^+$

$\gamma$

ATIC e- "bump"

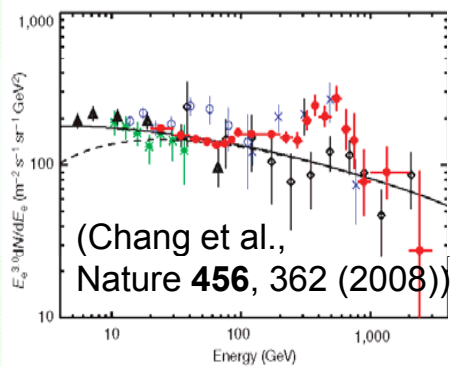

Fermi e- "non-bump"

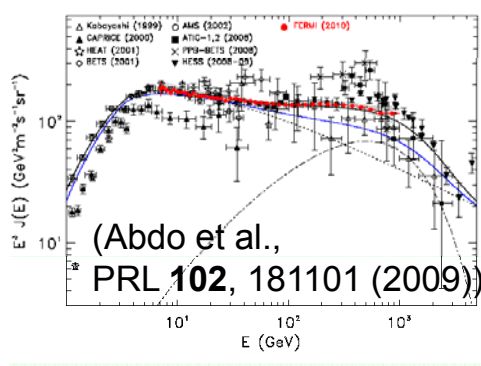

WMAP "haze"

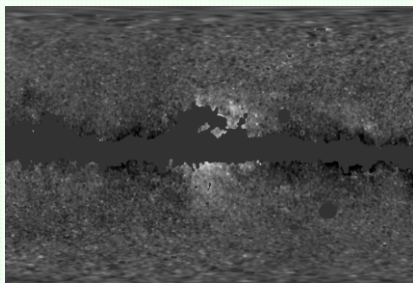

(Hooper, Finkbeiner & Dobler,  
 PRD **76**, 083012 (2007))

PAMELA e+ excess

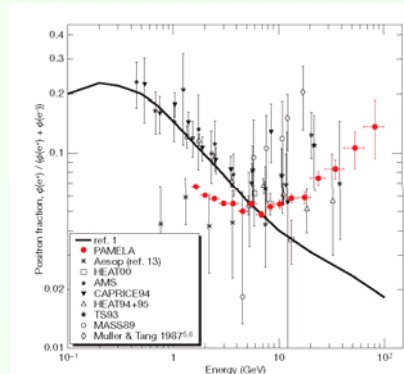

(Adriani et al.,  
 Nature **458**, 607 (2009))

2011: Fermi-LAT

$\gamma$ -ray limits  
 (Fermi, VERITAS,  
 MAGIC, HESS)

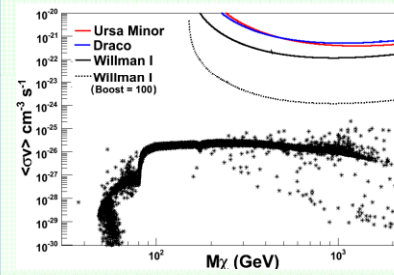

(Acciari et al.,  
 ApJ **720**, 1174 (2010))

Fermi GC excess

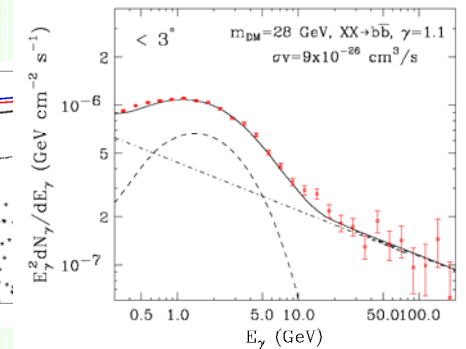

(Goodenough & Hooper,  
 arXiv:0910.2998v2)

PAMELA anti-protons

$\bar{p}$

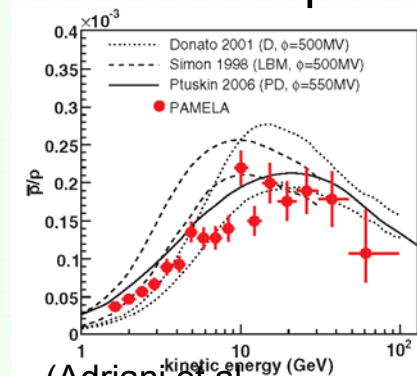

(Adriani et al.,  
 PRL **102**, 051101 (2009))

# Summary of cosmic-ray probes

<u>Particle</u>	<u>Kinematic Range</u>	<u>Experimental Challenges</u>	<u>Backgrounds</u>
$e^-$	> 100 GeV	particle ID	$e^-$ 's are ubiquitous in CR's !
$e^+$	> 20 GeV	p background	local sources secondary production
$\bar{p}$	> 20 GeV	large aperture	secondary production
$\bar{d}$	<b>&lt; 2 GeV</b>	<b>low flux</b>	<b>small background</b>

The unique possibilities of anti-deuterons as a background-free probe of new physics → a big interest from theoretical community, e.g.:

- F. Donato, N. Fornengo & P. Salati, Phys. Rev. **62**, 043003 (2000)
- J. Edsjo et al, JCAP Phys. **09**, 004 (2004)
- H. Baer & S. Profumo, Astroparticle Phys. **12**, 008 (2005)
- F. Donato, N. Fornengo, & D. Maurin, Phys. Rev. D **78**, 043506 (2008)
- M. Kadastik et al, arXiv:0908.157 (2009)
- C. Brauner & M. Cirelli, arXiv:0904.1165 (2009)
- Y. Cui, J. Mason, & L. Randall, arXiv:1006.0983 (2010)
- ... and many more (apologies if your paper is not here!).



# Why Anti-deuterons ?

Unlike anti-protons, which are easy to produce as secondary particles, anti-deuteron secondaries are severely suppressed at low energies.

Primary Component (DM):

$$\chi \chi \rightarrow \gamma, \bar{p}, \bar{d}$$

Secondary Component, includes:

$$p A \rightarrow \bar{d} X \quad [\text{via } p(\bar{p}n)n]$$

where  $A = p, \text{He}$

Anti-deuterons provide extremely clean signature, but low fluxes result in a daunting experimental challenge !

**New experiment**  
**→ General AntiParticle Spectrometer (GAPS)**

DM production of  $\bar{d}$

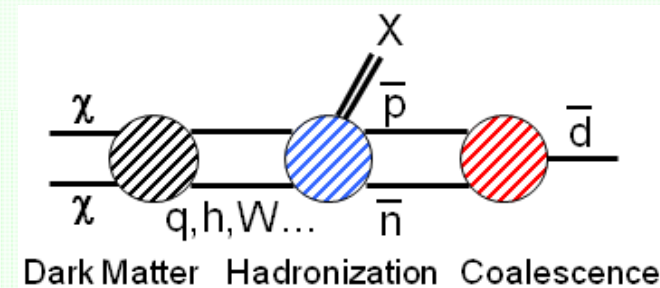

Anti-deuteron flux at the earth  
(w/propagation and solar modulation)

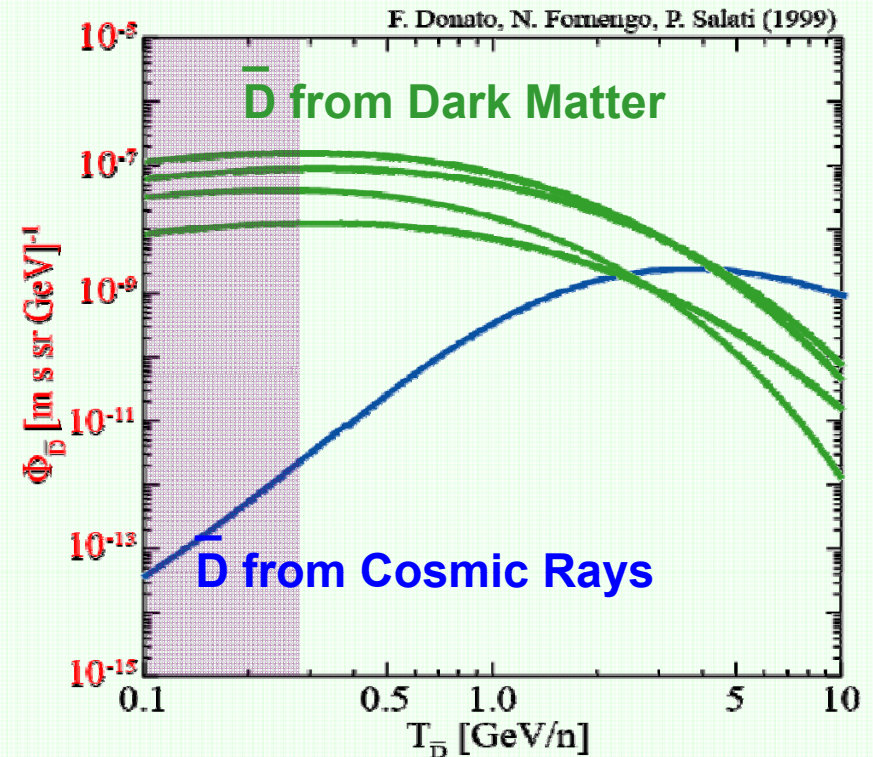

# BESS

## Balloon-borne Experiment with Superconducting Solenoid (Japan-US Collaboration)

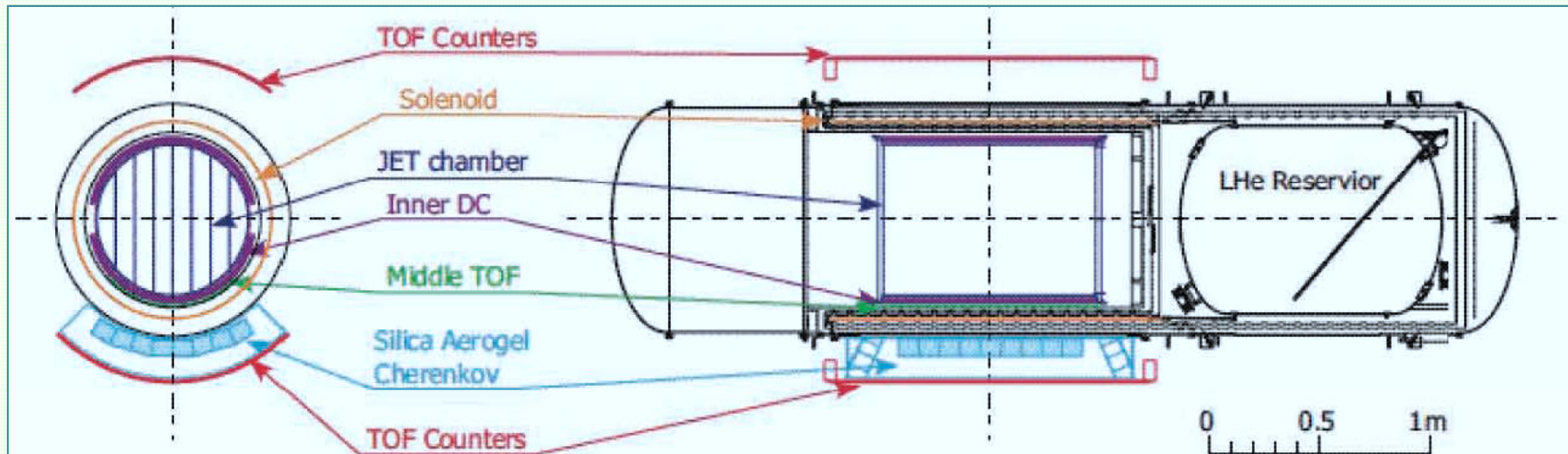

- Series of flights of increasing duration between 1993-2008.
- Large, uniform magnet (1T), precision tracker.
- Best limits on anti-He, anti-D.  
 $F(\text{anti-D}) < 10^{-4}/\text{m}^2/\text{s}/\text{sr}/\text{GeV}$
- **Heavy, complex experiment !**

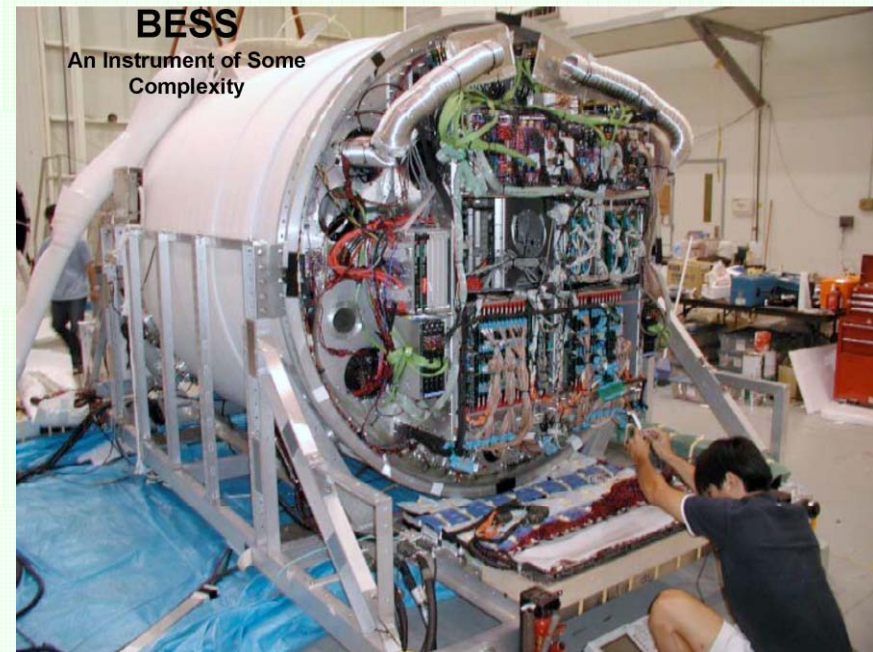



# AMS-2

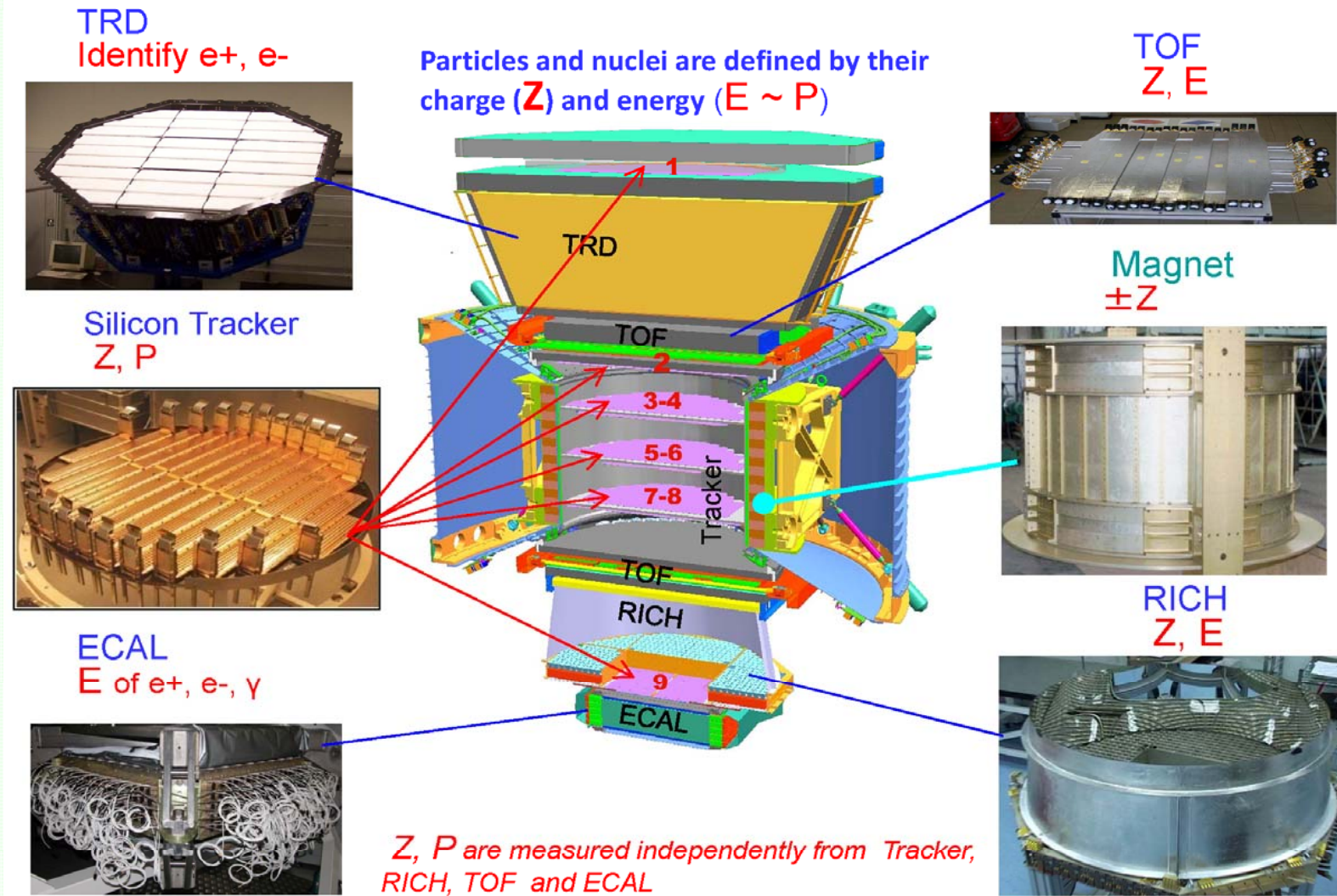

- anti-HE search.
- extend range of positron, anti-proton measurements.
- anti-deuteron search  $\rightarrow$  again, spectrometer technique.

# GAPS Collaboration

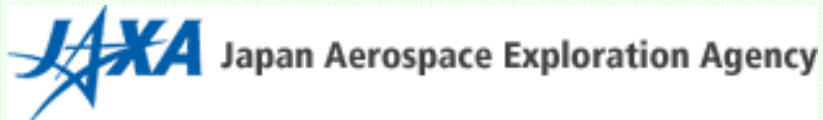

(+ LLNL, Univ. of Latvia)



Collaboration meeting, UCB (2010)

T. Aramaki, N. Bando, S. Boggs, W. Craig, P. von Doetinchem, H. Fuke, F.H. Gahbauer, C. Hailey(PI), J. Koglin, N. Madden, I. Mognet, K. Mori, R.A. Ong, A. Takada, T. Yoshida, J.A. Zweerink



# GAPS Detection Technique

- Conventional method of magnetic mass spectrometer is not optimal for GAPS. (Very large magnets with thin detector materials are needed for a deep survey).
- GAPS introduces an original method. GAPS utilizes the de-excitation sequence of exotic atoms.

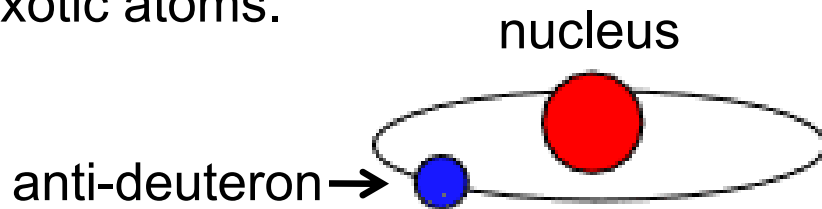

# GAPS Detection Technique

- Conventional method of magnetic mass spectrometer is not optimal for GAPS. (Very large magnets with thin detector materials are needed for a deep survey).

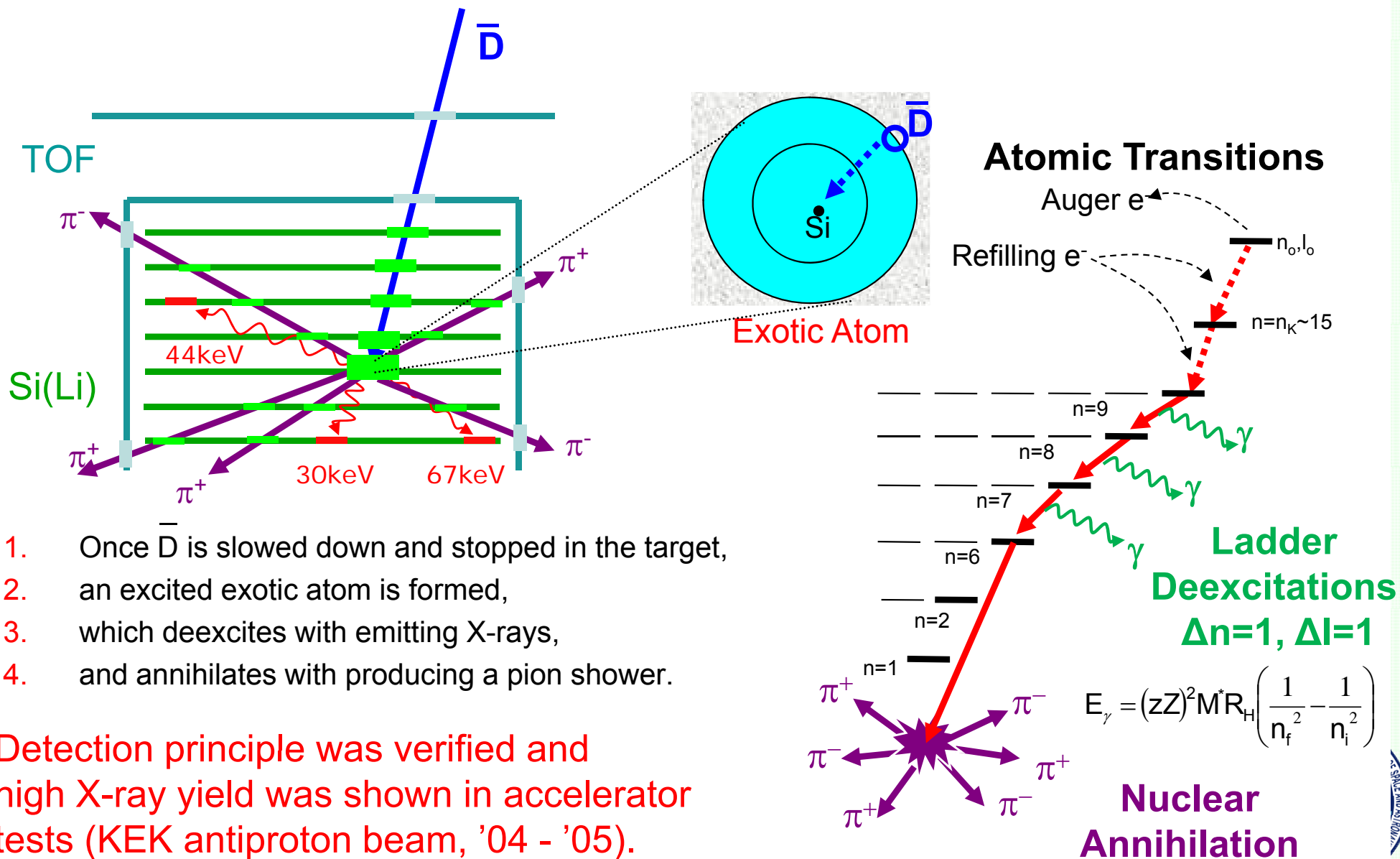

- Detection principle was verified and high X-ray yield was shown in accelerator tests (KEK antiproton beam, '04 - '05).



# GAPS Concept

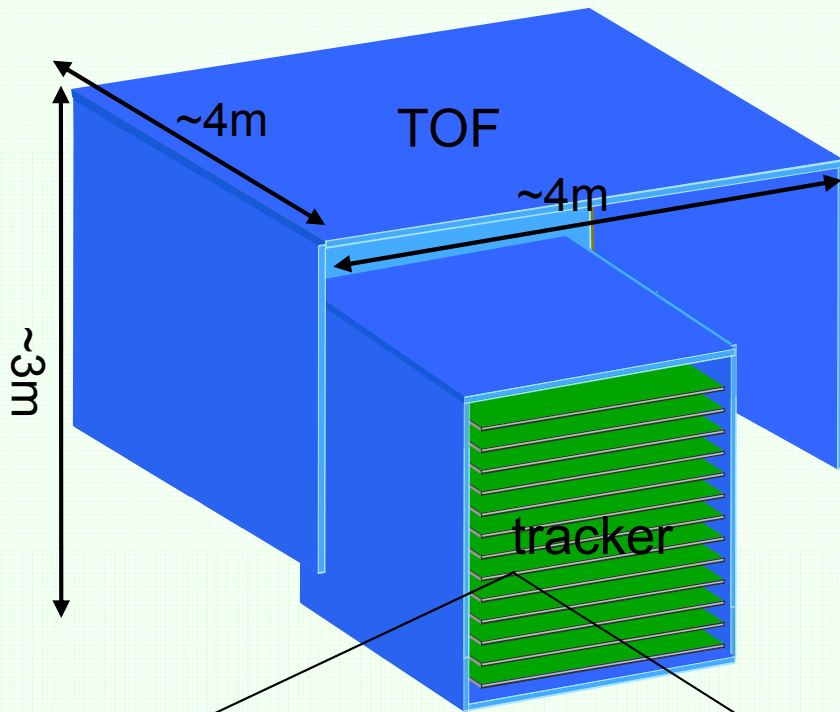

**GAPS consists of two detectors (acceptance  $\sim 2.7 \text{ m}^2\text{sr}$ ):**

**Si(Li) Detector (target and tracker):**

- Si(Li) tracker: 13 layers of Si(Li) wafers
- relatively low Z material
- good X-ray resolution
- circular modules segmented into 8 strips
  - 3D particle tracking
- 270 per layer (total:  $\sim 3500$ )
- timing:  $\sim 50 \text{ ns}$
- dual channel electronics
- 5-200 keV: X-rays (resolution:  $\sim 2 \text{ keV}$ )
- 0.1-200 MeV: charged particle

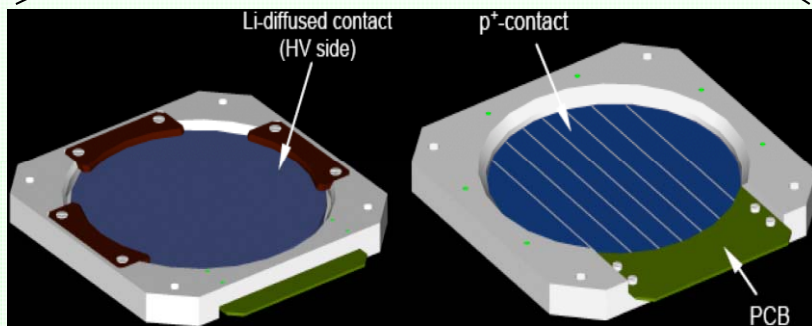

**Time of flight and anticoincidence shield:**

- plastic scintillator with PMTs surrounds tracker
- track charged particles,  $dE/dX$
- velocity measurement
- anticoincidence for charged particles

**LD Balloon flight in 2015 ?**

# Main Challenges for GAPS

---

- Basic detection technique has been established, but the difficulty is to translate to a full-scale instrument.
  - Large scale Si(Li) production at reasonable cost.
  - Building a hermetic detector (i.e. no cracks, etc.).
- Rare-event detector → backgrounds need to be fully modeled and understood.

Important: with GAPS, there are three ways to reject background:

1. Particle ID: TOF  $\beta$ , TOF veto, dE/dX & depth
  2. X-rays
  3. Pion track multiplicity
- A prototype / test experiment is essential: pGAPS (2012).



# Backgrounds

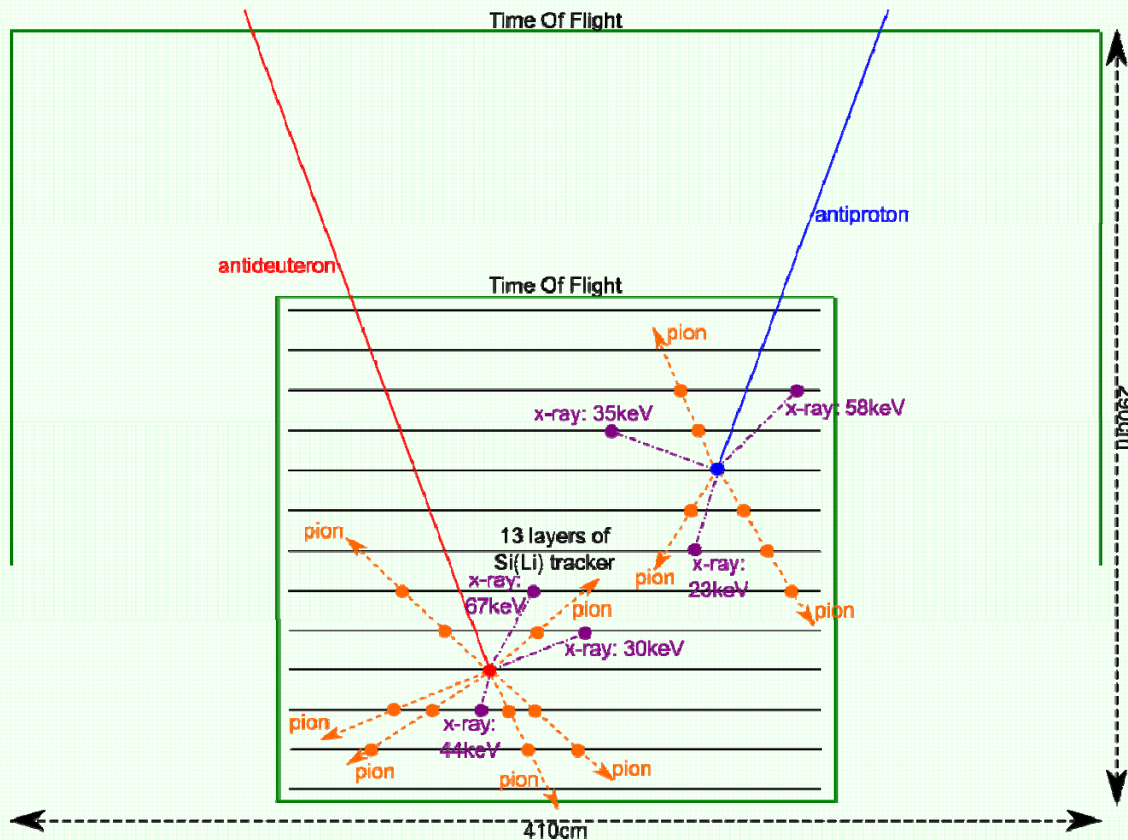

anti-P and anti-D interactions in GAPS

## GAPS needs very reliable particle identification:

- Identification uses:
  - TOF velocity and tracks
  - depth in tracker
  - X-rays
  - pions from annihilation
- Important background sources for anti-deuteron events:
  - anti-protons
  - protons, electrons, neutrons in coincidence with cosmic X-rays
  - atmospheric production of anti-deuterons
  - etc...

**Detailed Monte-Carlo simulation required (in progress).**

# GAPS Timeline

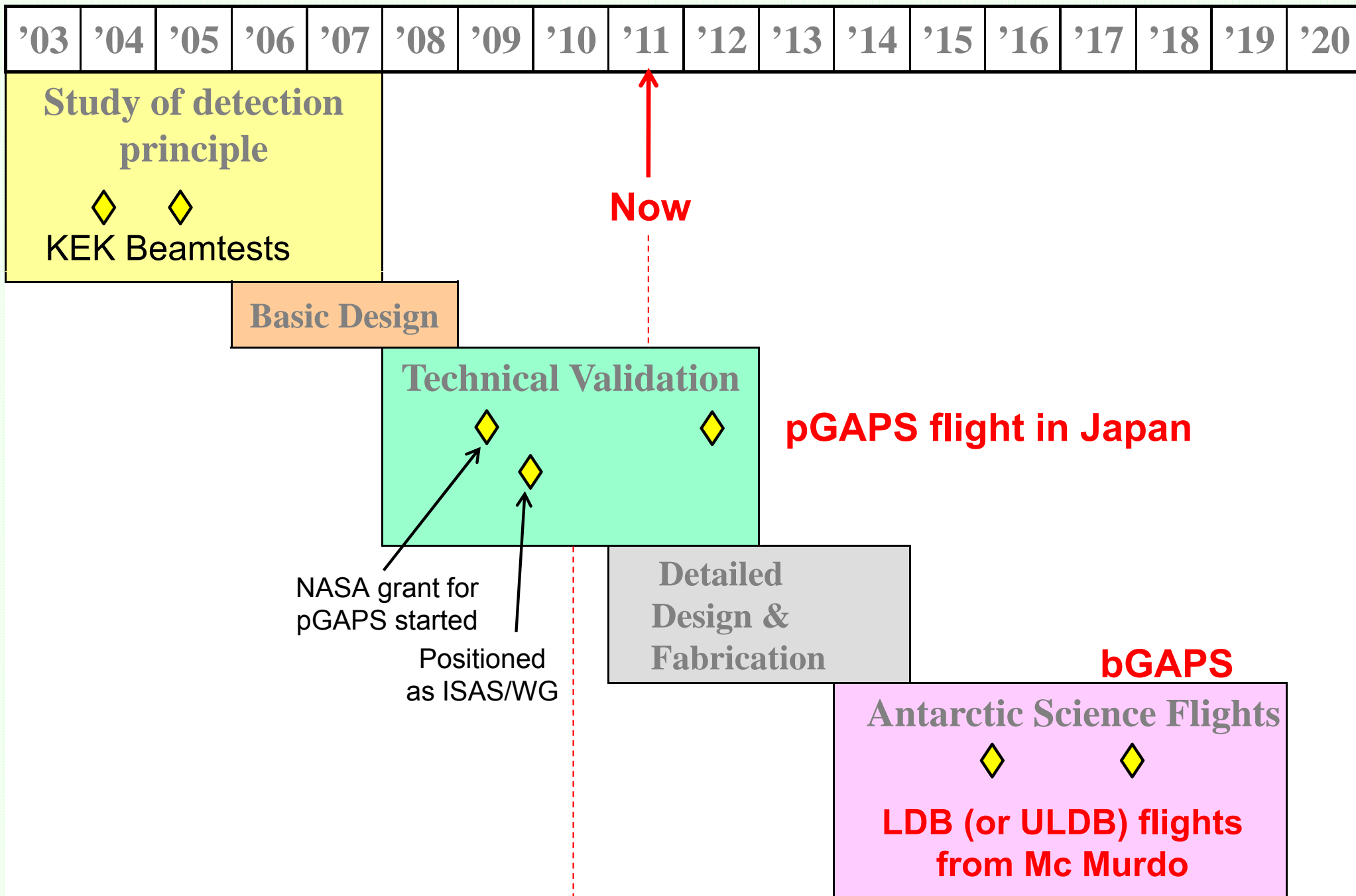



# Prototype Experiment

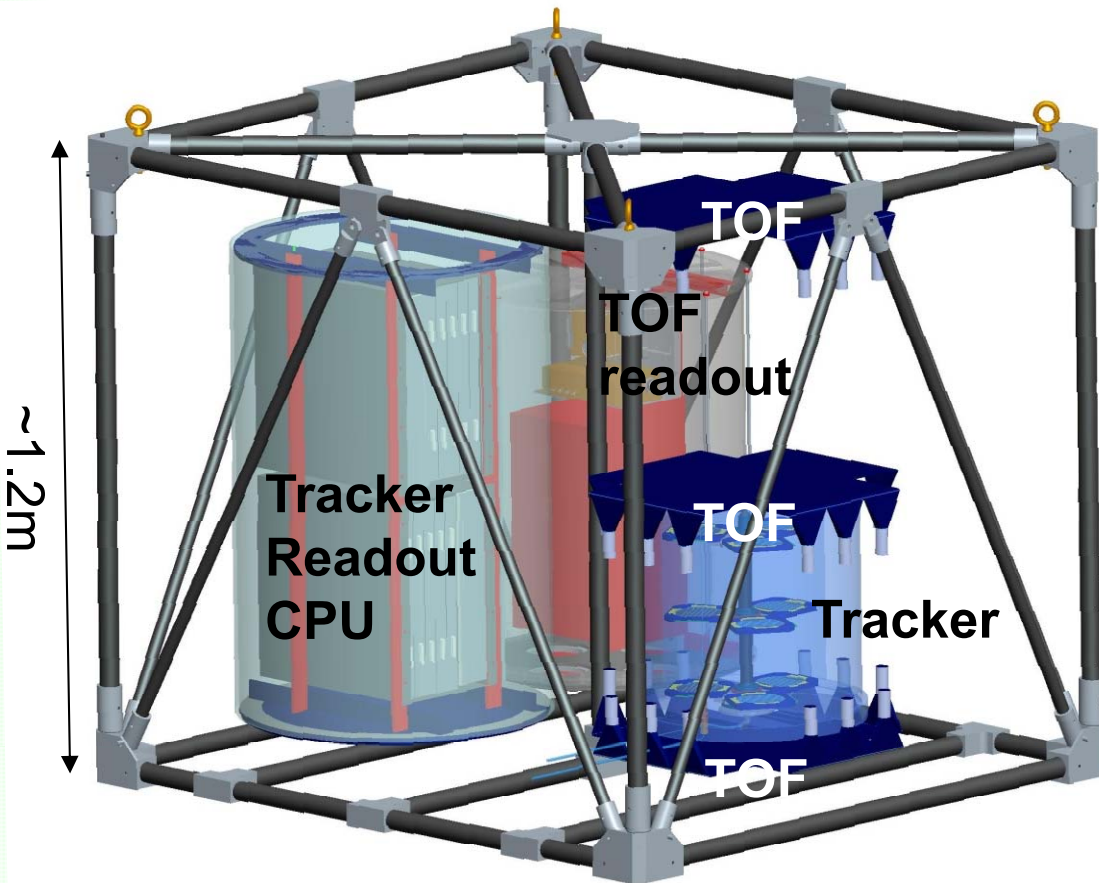

## Prototype GAPS (pGAPS) goals:

- demonstrate stable, low noise operation of components at float altitude and ambient pressure.
- demonstrate the Si(Li) cooling approach and verify thermal model.
- measure incoherent background level in a flight-like configuration.

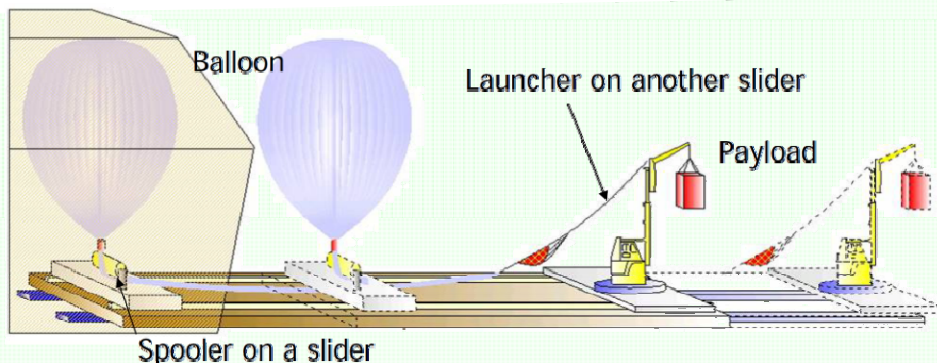

# Si(Li) Tracker (CU & UCB)

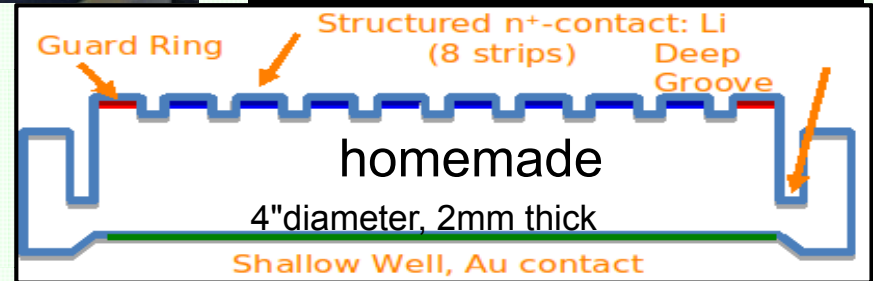
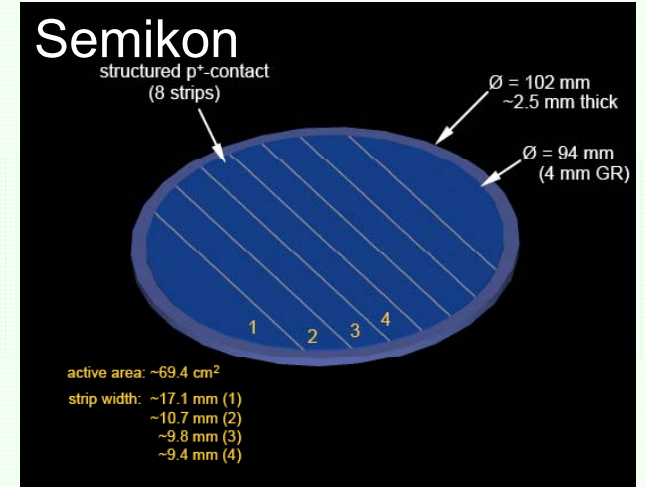
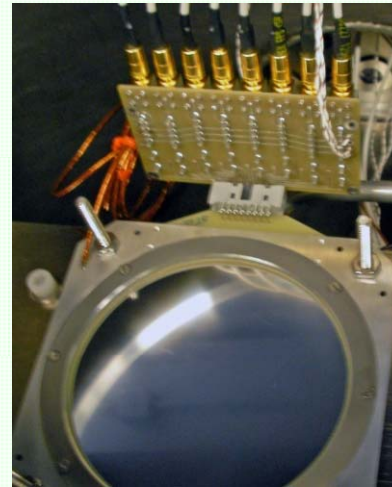
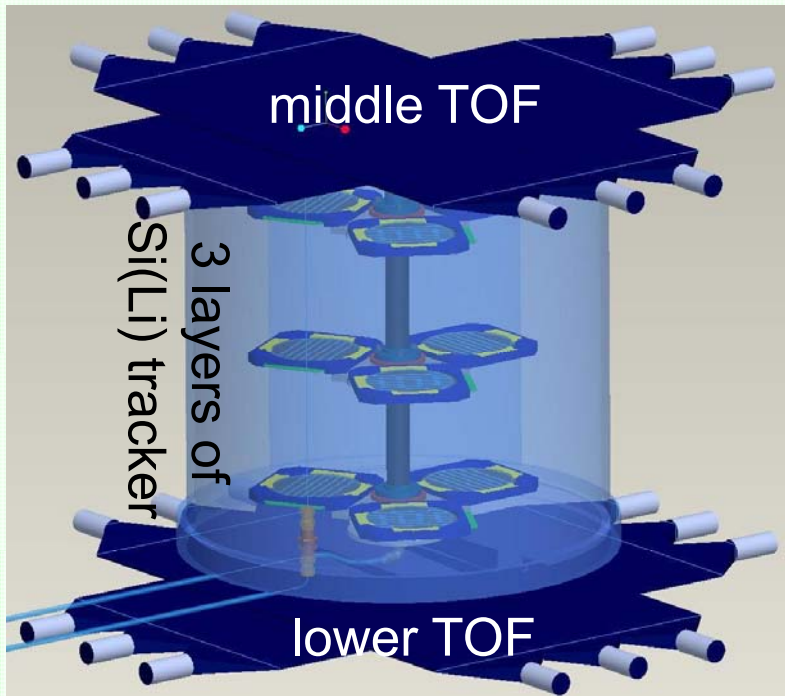

- 6 commercial Semikon detectors.
- homemade detectors (test for the bGAPS fabrication).
- Energy resolution  $< 3$  keV @ 60keV.
- operation at ambient pressure. (8mbar).
- cooling system delivers:  $-35^{\circ}\text{C}$ .





# Time-of-Flight System (UCLA)

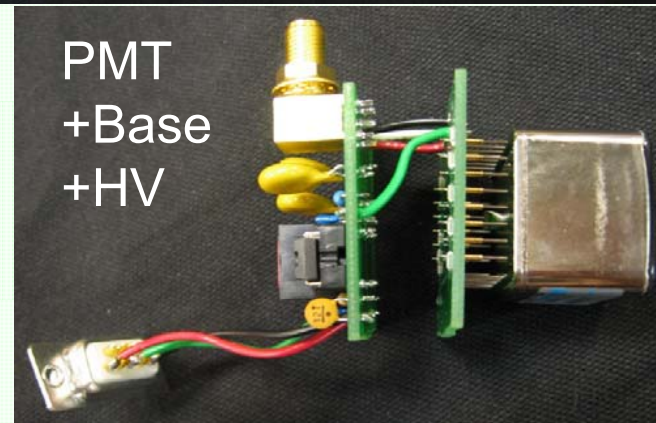
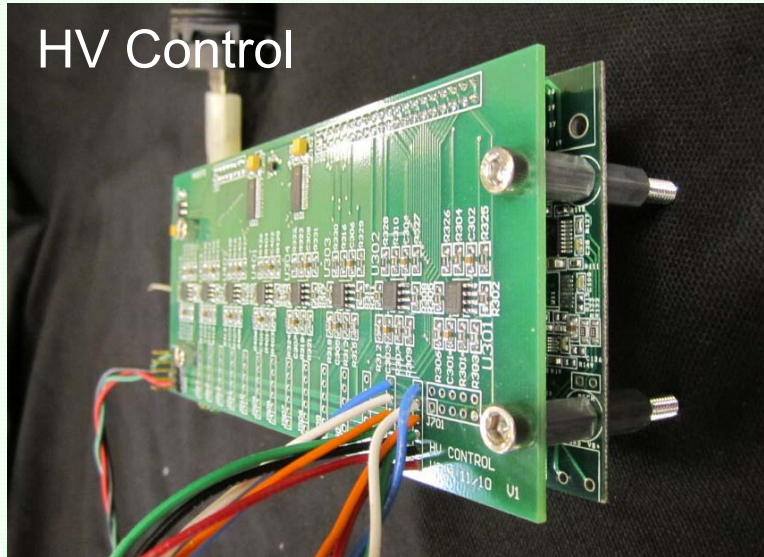

- 3 planes of TOF  
1 plane = 3×3 crossed paddles  
= **18 paddles and 36 PMTs**
- 3mm scintillator (EJ-200, BC-408)
- Hamamatsu R-7600 PMT (UBA)
- timing resolution: **< 400 ps**
- charge resolution: **< 0.30 e**
- angular resolution: **8°**

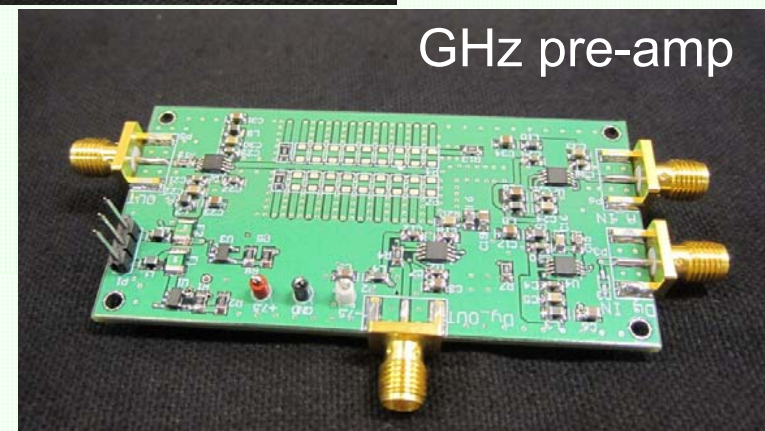



# Integration at UCB/SSL (July 2011)

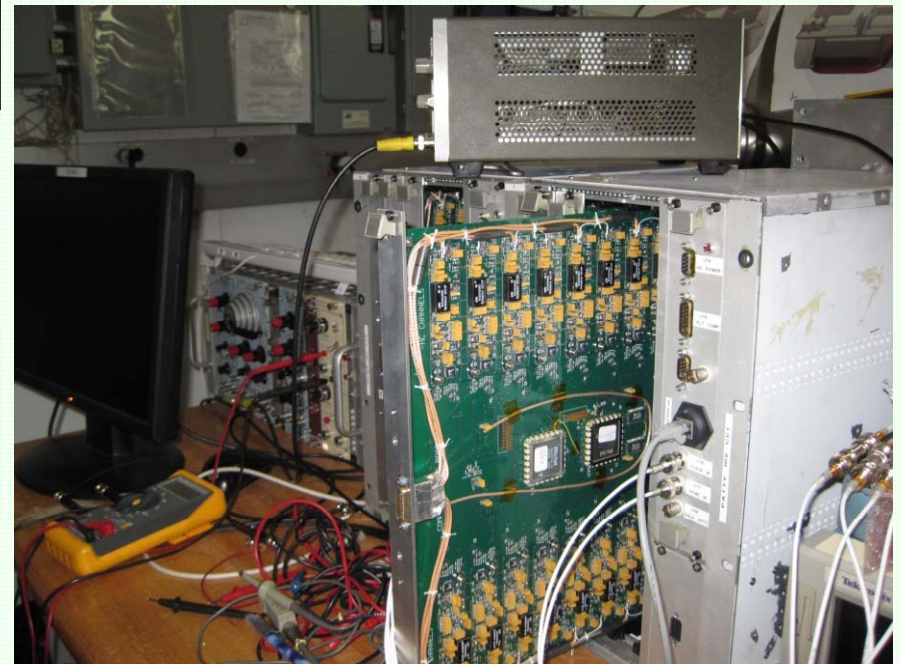
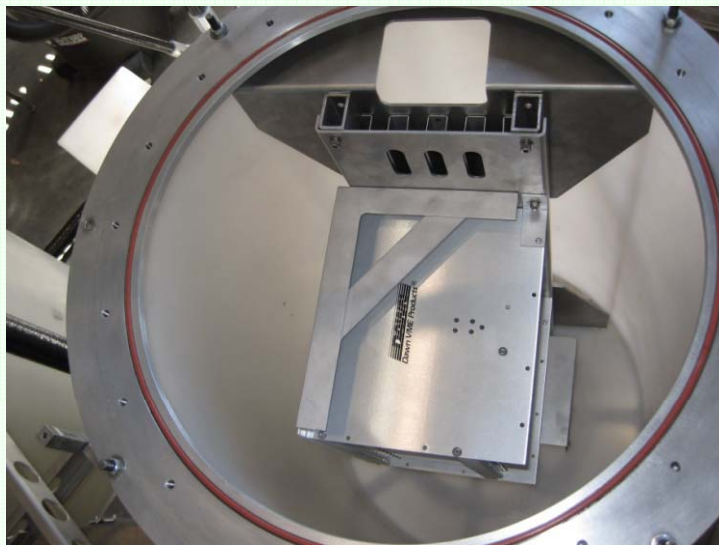



# Status & Future Prospects

---

## **GAPS** Program:

- Prototype instrument largely integrated now – ready to be flown in 2012.
- Developing LDB instrument for possible first flight in 2015.
- ULDB (300 day) flights, when available, would greatly improve sensitivity reach.
- **(Possible future satellite instrument).**

# GAPS anti-D Sensitivity Reach

- Cosmic anti-D have never been detected. Could be produced by new physics.
- Primary anti-D production:
  - Supersymmetry (LSP)
  - Kaluza-Klein UED (LKP)
  - Warped ED (LZP)
  - Primordial BH's
- Sub-GeV region essentially background free; the detection of even a single, clean event is important.
- **GAPS will extend sensitivity reach by 2-3 orders of magnitude, using very different technique than BESS, AMS or any previous experiment.**

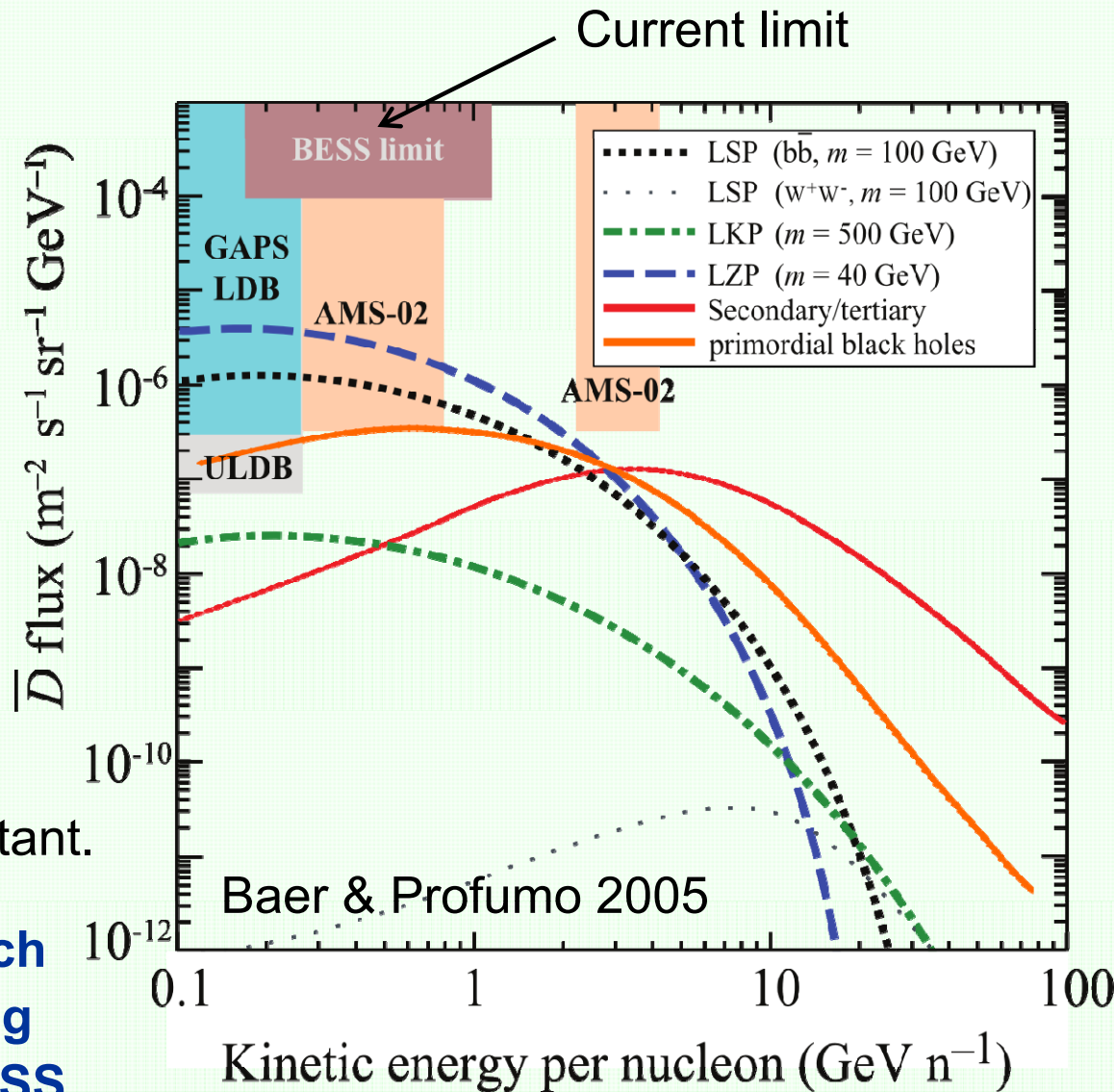

# Status & Future Prospects

---

## **GAPS** Program:

- Prototype instrument largely integrated now – ready to be flown in 2012.
- Developing LDB instrument for possible first flight in 2015.
- ULDB (300 day) flights, when available, would greatly improve sensitivity reach.
- **(Possible future satellite instrument).**

**AMS** now launched with good anti-D sensitivity

→ results expected in several years time (2014?).

## **Importance of developing GAPS to flight status:**

- Anti-D is unique probe, currently only two experiments seriously considered for next decade (c.f. ~20 direct detection).
- GAPS is completely complementary to AMS:
  - If AMS sees something, crucial to confirm using different technique, different backgrounds, etc. (c.f. direct detection).
  - If AMS sets initial limit, strong need to push sensitivity further.
- Long timetable → essential to develop GAPS technique now.



# Uncertainties I

---

There are a number of key uncertainties:

## Sensitivity:

- Instrument aperture:  
detector performance, triggering strategy, etc.
- Backgrounds

**Prototype flight will help with these items.**

## Flux:

- DM density: DM halo model.
- Production of anti-D (coalescence of anti-baryons).
- **Propagation in MW.**
- (Solar modulation).

Propagation appears to produce the largest overall uncertainty.

# Uncertainties II

## Uncertainties in Primary Antideuteron Flux

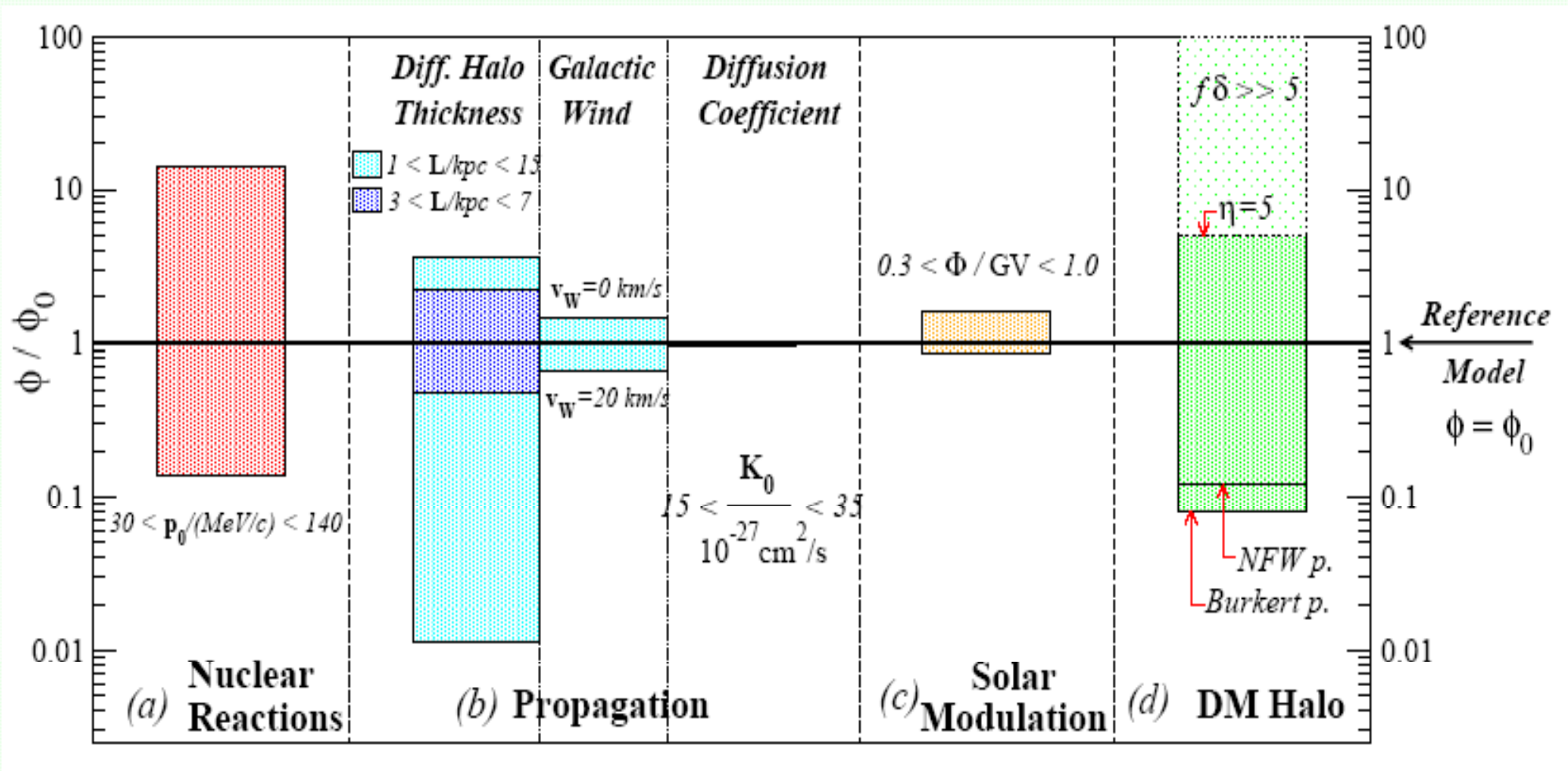

# Uncertainties III

Donato, Fornengo & Maurin 2008

BACKGROUND

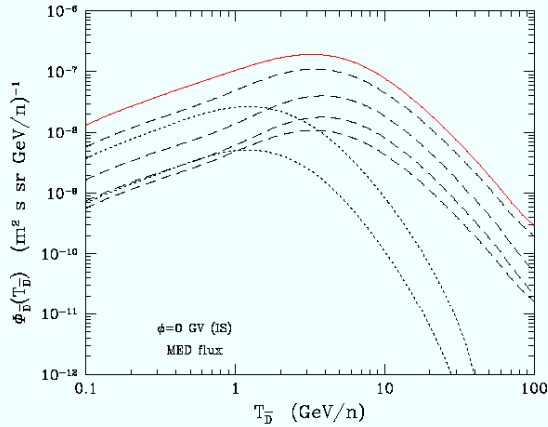

FIG. 1: Contribution of all nuclear channels to the  $\bar{d}$  secondary flux. Dashed lines, from top to bottom refer to: p+H, p+He, He+H, He+He. Dotted lines, from top to bottom stand for:  $\bar{p}$ +H,  $\bar{p}$ +He. Solid line: sum of all the components.

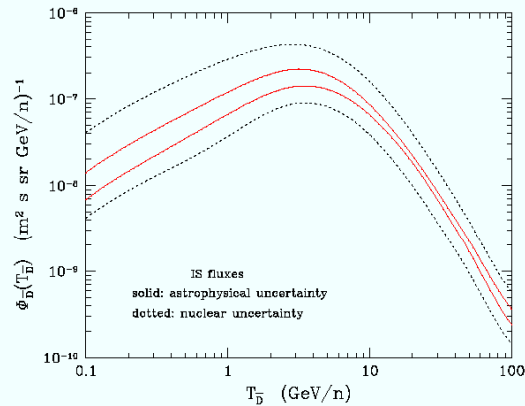

FIG. 2: Dominant uncertainties on the interstellar secondary  $\bar{d}$  flux. Solid lines: propagation uncertainty band. Dotted lines: nuclear uncertainty band.

SIGNAL

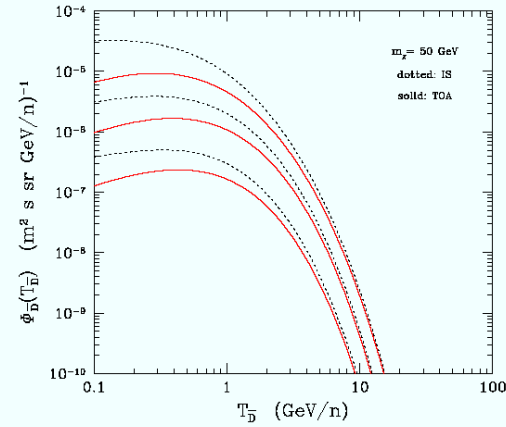

FIG. 4: Antideuteron flux for WIMPs of  $m_{\chi}=50$  GeV. Dotted (black) lines refer to the interstellar flux, solid (red) lines stand for the top-of-atmosphere flux, modulated at solar minimum. For each set of curves, the three lines refer to the maximal, median and minimal propagation configurations defined in Table I.

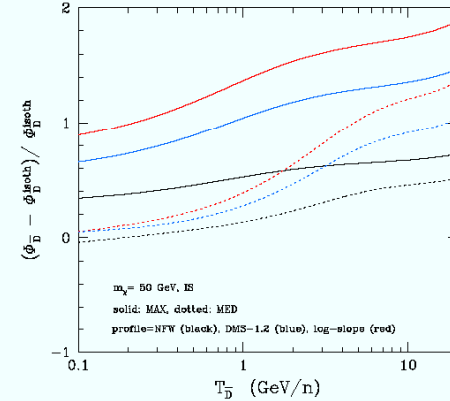
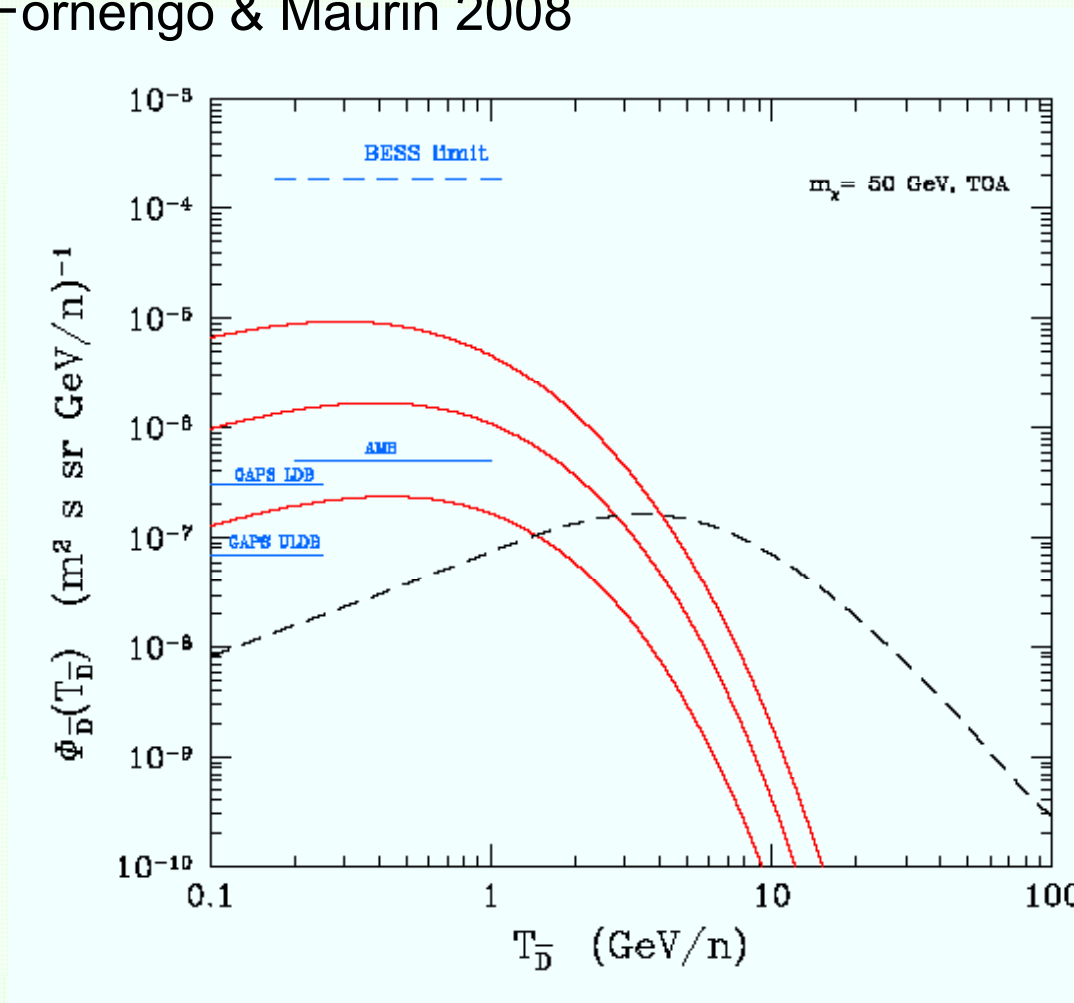

FIG. 6: Effect of changing the DM halo density profile, for a  $m_{\chi}=50$  GeV WIMP and for the “max” (solid) and “med” (dotted) configurations of Table I. The effect is shown as the relative change in the IS antideuteron flux as compared with the reference case of a cored isothermal profile. The lower (black) lines refer to the NFW profile [68], the median (blue) lines to a cuspy profile with 1.2 slope [69] and the upper (red) ones to the N04 profile of Ref. [61].



# Overall S/N

Donato, Fornengo & Maurin 2008



50 GeV WIMP  
three propagation models

- Non-negligible uncertainty in background estimate.
- Dominant uncertainty relates to signal estimate, coming from propagation  
→ will PAMELA (AMS) results help with this?
- GAPS and AMS provide major improvement over earlier measurements.

# GAPS Summary

---

- Gravitational evidence for DM is very strong.  
The majority of DM is non-baryonic and is not hot.
- Particle DM has motivation from astrophysics & particle physics.  
WIMP CDM is cool idea ... it might even be right.
- Indirect detection is promising; it is able to test the particle hypothesis and is complementary to other methods.
- Anti-deuterons are a unique probe of DM, **but as interesting is the question of whether they even exist in the cosmic rays.**
- GAPS is a new balloon instrument using the exotic atom technique to search for anti-deuterons.  
Prototype flight scheduled for 2012.  
LDB instrument currently in proposal stage.  
→ **We welcome input from theoretical community.**

*“Great scientific discoveries have been made by men seeking to verify quite erroneous theories about the nature of things,” Aldous Huxley, 1929.*